

AV Controller

DHC-9.9

Instruction Manual

Integra

Thank you for purchasing an Integra AV controller. Please read this manual thoroughly before making connections and plugging in the unit. Following the instructions in this manual will enable you to obtain optimum performance and listening enjoyment from your new AV controller. Please retain this manual for future reference.

WARNING:

TO REDUCE THE RISK OF FIRE OR ELECTRIC SHOCK, DO NOT EXPOSE THIS APPARATUS TO RAIN OR MOISTURE.

CAUTION:

TO REDUCE THE RISK OF ELECTRIC SHOCK, DO NOT REMOVE COVER (OR BACK). NO USER-SERVICEABLE PARTS INSIDE. REFER SERVICING TO QUALIFIED SERVICE PERSONNEL.



WARNING
RISK OF ELECTRIC SHOCK
DO NOT OPEN

AVIS
RISQUE DE CHOC ELECTRIQUE
NE PAS OUVRIR



The lightning flash with arrowhead symbol, within an equilateral triangle, is intended to alert the user to the presence of uninsulated "dangerous voltage" within the product's enclosure that may be of sufficient magnitude to constitute a risk of electric shock to persons.



The exclamation point within an equilateral triangle is intended to alert the user to the presence of important operating and maintenance (servicing) instructions in the literature accompanying the appliance.

Important Safety Instructions

1. Read these instructions.
2. Keep these instructions.
3. Heed all warnings.
4. Follow all instructions.
5. Do not use this apparatus near water.
6. Clean only with dry cloth.
7. Do not block any ventilation openings. Install in accordance with the manufacturer's instructions.
8. Do not install near any heat sources such as radiators, heat registers, stoves, or other apparatus (including amplifiers) that produce heat.
9. Do not defeat the safety purpose of the polarized or grounding-type plug. A polarized plug has two blades with one wider than the other. A grounding type plug has two blades and a third grounding prong. The wide blade or the third prong are provided for your safety. If the provided plug does not fit into your outlet, consult an electrician for replacement of the obsolete outlet.
10. Protect the power cord from being walked on or pinched particularly at plugs, convenience receptacles, and the point where they exit from the apparatus.
11. Only use attachments/accessories specified by the manufacturer.
12. Use only with the cart, stand, tripod, bracket, or table specified by the manufacturer, or sold with the apparatus. When a cart is used, use caution when moving the cart/apparatus combination to avoid injury from tip-over. 

PORTABLE CART WARNING
S3125A
13. Unplug this apparatus during lightning storms or when unused for long periods of time.
14. Refer all servicing to qualified service personnel. Servicing is required when the apparatus has been damaged in any way, such as power-supply cord or plug is damaged, liquid has been spilled or objects have fallen into the apparatus, the apparatus has been exposed to rain or moisture, does not operate normally, or has been dropped.
15. Damage Requiring Service
Unplug the apparatus from the wall outlet and refer servicing to qualified service personnel under the following conditions:
 - A. When the power-supply cord or plug is damaged,
 - B. If liquid has been spilled, or objects have fallen into the apparatus,
 - C. If the apparatus has been exposed to rain or water,
 - D. If the apparatus does not operate normally by following the operating instructions. Adjust only those controls that are covered by the operating instructions as an improper adjustment of other controls may result in damage and will often require extensive work by a qualified technician to restore the apparatus to its normal operation,
 - E. If the apparatus has been dropped or damaged in any way, and
 - F. When the apparatus exhibits a distinct change in performance this indicates a need for service.
16. Object and Liquid Entry
Never push objects of any kind into the apparatus through openings as they may touch dangerous voltage points or short-out parts that could result in a fire or electric shock.
The apparatus shall not be exposed to dripping or splashing and no objects filled with liquids, such as vases shall be placed on the apparatus.
Don't put candles or other burning objects on top of this unit.
17. Batteries
Always consider the environmental issues and follow local regulations when disposing of batteries.
18. If you install the apparatus in a built-in installation, such as a bookcase or rack, ensure that there is adequate ventilation.
Leave 20 cm (8") of free space at the top and sides and 10 cm (4") at the rear. The rear edge of the shelf or board above the apparatus shall be set 10 cm (4") away from the rear panel or wall, creating a flue-like gap for warm air to escape.

Precautions

1. **Recording Copyright**—Unless it's for personal use only, recording copyrighted material is illegal without the permission of the copyright holder.
2. **AC Fuse**—The AC fuse inside the unit is not user-serviceable. If you cannot turn on the unit, contact your Onkyo dealer from whom you purchased this unit.
3. **Care**—Occasionally you should dust the unit all over with a soft cloth. For stubborn stains, use a soft cloth dampened with a weak solution of mild detergent and water. Dry the unit immediately afterwards with a clean cloth. Don't use abrasive cloths, thinners, alcohol, or other chemical solvents, because they may damage the finish or remove the panel lettering.
4. **Power**
WARNING
BEFORE PLUGGING IN THE UNIT FOR THE FIRST TIME, READ THE FOLLOWING SECTION CAREFULLY.
AC outlet voltages vary from country to country. Make sure that the voltage in your area meets the voltage requirements printed on the unit's rear panel (e.g., AC 230 V, 50 Hz or AC 120 V, 60 Hz).
The power cord plug is used to disconnect this unit from the AC power source. Make sure that the plug is readily operable (easily accessible) at all times.
For North American model
Pressing the [On/Standby] button to select Standby mode does not fully shutdown the unit. If you do not intend to use the unit for an extended period, remove the power cord from the AC outlet.
5. **Preventing Hearing Loss**
Caution
Excessive sound pressure from earphones and headphones can cause hearing loss.
6. **Batteries and Heat Exposure**
Warning
Batteries (battery pack or batteries installed) shall not be exposed to excessive heat as sunshine, fire or the like.
7. **Never Touch this Unit with Wet Hands**—Never handle this unit or its power cord while your hands are wet or damp. If water or any other liquid gets inside this unit, have it checked by your Onkyo dealer.
8. **Handling Notes**
 - If you need to transport this unit, use the original packaging to pack it how it was when you originally bought it.
 - Do not leave rubber or plastic items on this unit for a long time, because they may leave marks on the case.
 - This unit's top and rear panels may get warm after prolonged use. This is normal.
 - If you do not use this unit for a long time, it may not work properly the next time you turn it on, so be sure to use it occasionally.

For U.S. models

FCC Information for User

CAUTION:

The user changes or modifications not expressly approved by the party responsible for compliance could void the user's authority to operate the equipment.

NOTE:

This equipment has been tested and found to comply with the limits for a Class B digital device, pursuant to Part 15 of the FCC Rules. These limits are designed to provide reasonable protection against harmful interference in a residential installation.

This equipment generates, uses and can radiate radio frequency energy and, if not installed and used in accordance with the instructions, may cause harmful interference to radio communications. However, there is no guarantee that interference will not occur in a particular installation. If this equipment does cause harmful interference to radio or television reception, which can be determined by turning the equipment off and on, the user is encouraged to try to correct the interference by one or more of the following measures:

- Reorient or relocate the receiving antenna.
- Increase the separation between the equipment and receiver.
- Connect the equipment into an outlet on a circuit different from that to which the receiver is connected.
- Consult the dealer or an experienced radio/TV technician for help.

For Canadian Models

NOTE: THIS CLASS B DIGITAL APPARATUS COMPLIES WITH CANADIAN ICES-003.

For models having a power cord with a polarized plug:

CAUTION: TO PREVENT ELECTRIC SHOCK, MATCH WIDE BLADE OF PLUG TO WIDE SLOT, FULLY INSERT.

Modèle pour les canadien

REMARQUE: CET APPAREIL NUMÉRIQUE DE LA CLASSE B EST CONFORME À LA NORME NMB-003 DU CANADA.

Sur les modèles dont la fiche est polarisée:

ATTENTION: POUR ÉVITER LES CHOCS ÉLECTRIQUES, INTRODUIRE LA LAME LA PLUS LARGE DE LA FICHE DANS LA BORNE CORRESPONDANTE DE LA PRISE ET POUSSER JUSQU'AU FOND.

Supplied Accessories

Make sure you have the following accessories:

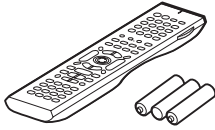

Remote control and three batteries (AA/R6)



Speaker setup microphone

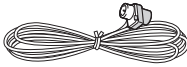

Indoor FM antenna



AM loop antenna

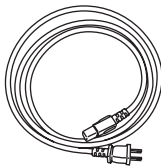

Power cord

(Power cord varies from country to country.)

* In catalogs and on packaging, the letter at the end of the product name indicates the color. Specifications and operation are the same regardless of color.

Contents

Introduction	
Supplied Accessories	4
Features	6
Multiroom Capability	8
Front & Rear Panels	9
Front Panel	9
Display	11
Rear Panel	12
Remote Controller	15
Installing the Batteries	15
Aiming the Remote Controller	15
About the Remote Controller Modes	16
Receiver/Tape Mode	16
DVD Mode	18
CD/CDR/MD Modes	19
Dock Mode	20
About Home Theater	21
Enjoying Home Theater	21
Connection	
Connecting the AV Controller	22
Connecting Your Speakers	22
Connecting a Power Amplifier with RCA Inputs	23
Connecting a Power Amplifier with XLR Inputs	24
Bi-amping the Front Speakers	25
Connecting Antenna	26
About AV Connections	28
Connecting Both Audio & Video	29
Which Connections Should I Use?	29
Connecting a TV or Projector	31
Connecting a DVD player	32
Connecting a VCR or DVD Recorder for Playback	34
Connecting a VCR or DVD Recorder for Recording	35
Connecting a Satellite, Cable, Terrestrial Set-top box, or Other Video Source	36
Connecting Components with HDMI	37
Connecting a Game Console	39
Connecting a Camcorder or Other Device	40
Connecting a CD Player or Turntable	41
Connecting a Cassette, CDR, MiniDisc, or DAT Recorder	42
Connecting a Balanced Audio Source	42
Connecting an RI Dock	43
Connecting the Power Cords of Other Components (North American model only)	43
Connecting Integra/Onkyo RI Components	44
Connecting the Power Cord	44
Turning On the AV Controller	45
Turning On and Standby	45
First Time Setup	
First Time Setup	46
Monitor Setup	46
Selecting the Language used for the onscreen setup menus	47
Using the Onscreen Setup Menus	48
Monitor Out Setup	49
Video Input Setup	50
Digital Audio Input Setup	53
Analog Audio Input Setup	54
Speaker Settings	55
TV Format Setup (not North American models)	56
AM Frequency Step Setup (on some models)	57
Changing the Input Display	57
Automatic Speaker Setup (Audyssey MultEQ® XT)	58

Basic Operation	
Basic Operations	64
Selecting the Input Source	64
Setting the Display Brightness	65
Adjusting Speaker Levels	65
Muting the AV Controller	65
Using the Sleep Timer	66
Using Headphones	66
Adjusting the Bass & Treble	66
Displaying Source Information	66
Listening to the Radio	67
Listening to AM/FM Stations	67
Presetting AM, FM, XM, and SIRIUS Stations	69
Listening to HD Radio™ Stations (North American model only)	70
Using RDS	72
Listening to XM Satellite Radio® (North American Model Only)	74
Listening to SIRIUS Satellite Radio® (North American Models Only)	80
Recording	89
Recording the Input Source	89
Recording from Different AV Sources	89
Using the Listening Modes	
Using the Listening Modes	90
Selecting the Listening Modes	90
Listening Modes Available for Each Source Format	91
About the Listening Modes	97
Advanced Setup	
Advanced Setup	101
Menu Map	101
Monitor Out Setup	102
Speaker Setup	104
Audio Adjust	113
Using the Music Optimizer	116
Using the Re-EQ Function	116
Using the Late Night Function	117
Source Setup	117
Listening Mode Presets	122
Miscellaneous Setup	123
Hardware Setup	125
Network Settings	127
Lock Setup	128
Selecting Audio Inputs	129
Specifying the Digital Signal Format	129
Zone 2 and Zone 3	
Zone 2 and Zone 3	130
Connecting Zone 2	130
Connecting Zone 3	131
Zone 2/Zone 3 Out Settings	132
Using Zone 2 and Zone 3	132
Using the 12V Triggers	135
Using the Remote Controller in Zone 2/3 and Multiroom Control Kits	136
Controlling Other Components	
Controlling Other Components	137
Entering Remote Control Codes	137
Resetting the Remote Controller	138
Learning Commands	140
Using Macros	141
Others	
Troubleshooting	142
Specifications	147

Features

Processing

- HDMI Audio and Video Processing (Deep Color, x.v.Color, Lip Sync, DTS^{®1}-HD Master Audio, DTS-HD High Resolution Audio, Dolby TrueHD^{*2}, Dolby Digital Plus, SA-CD and Multi-CH PCM)
- THX Ultra2 Plus^{*3} Certified
- HQV-Reon-VX Video Processing with 1080p Video Upscaling of All Video Sources via HDMI
- Component Video Upconversion
- Burr-Brown 192 kHz/24-bit D/A Converters
- Three-TI (Aureus) 32-Bit DSP Chips
- Neural Surround^{*4}, THX-Neural
- Theater-Dimensional^{*5} virtual surround sound
- DSD Direct
- Re-EQ^{*6} function

Connections

- Balanced XLR stereo input
- Balanced XLR 7.1-channel preouts, with front bi-amping capability
- 4 HDMI^{*7} Inputs and 2 Outputs
- Onkyo **RIHD** for System Control
- 6 Digital Inputs (3 Optical / 3 Coaxial), 1 Output (Optical)
- 6 S-Video Inputs / 2 Outputs
- Component Video Switching (3 Inputs/2 Outputs)
- Zone 2 and Zone 3 Pre Out, and subwoofer preouts
- IR Input/Output and 12 V Trigger
- RS232 Port for Interface Control

Miscellaneous

- SIRIUS Ready^{*8} / XM Ready^{*9} with XMHD Surround (North American models only)
- HD Radio^{*10} reception (North American models only)
- 40 SIRIUS/XM/AM/FM Presets (North American models)
- 40 AM/FM Presets (European and Asian models)
- Music Optimizer^{*11} for Compressed Music Files
- Audyssey MultEQ[®] XT^{*12} to Correct Room Acoustic Problems
- Audyssey Dynamic EQ^{™12} Loudness Correction
- Audyssey Dynamic Volume^{™*12}
- Independent Crossover Adjustment (40/45/50/55/60/70/80/90/100/110/120/130/150/200 Hz)
- ISF (Imaging Science Foundation) Video Calibration
- Newly Designed GUI for System Set-up
- Compatible with RI Dock for iPod
- Preprogrammed **RI**-Compatible Remote with 3 Macros and Mode-Key LEDs

***1**  **DTS-HD Master Audio**

Manufactured under license under U.S. Patent #'s: 5,451,942; 5,956,674; 5,974,380; 5,978,762; 6,226,616; 6,487,535 & other U.S. and worldwide patents issued & pending. DTS is a registered trademark and the DTS logos, Symbol, DTS-HD and DTS-HD Master Audio are trademarks of DTS, Inc. ©1996-2007 DTS, Inc. All Rights Reserved.

***2**  **DOLBY TRUEHD**

Manufactured under license from Dolby Laboratories. "Dolby", "Pro Logic" and the double-D symbol are trademarks of Dolby Laboratories.

***3**  **THX ULTRA 2 PLUS**

THX and Ultra2 Plus are trademarks of THX Ltd. THX may be registered in some jurisdictions. All rights reserved. Surround EX is a trademark of Dolby Laboratories. Used with permission.

***4**  **neural SURROUND THX TECHNOLOGIES**

Neural Surround is a trademark owned by Neural Audio Corporation, THX is a trademark of THX Ltd., which may be registered in some jurisdictions. All rights reserved.

***5**  **Theater-Dimensional**

Theater-Dimensional is a trademark of Onkyo Corporation.

***6** Re-Equalization and the "Re-EQ" logo are trademarks of THX Ltd.

***7** **HDMI**

HDMI, the HDMI logo and High Definition Multimedia Interface are trademarks or registered trademarks of HDMI Licensing, LLC.

***8**  **SIRIUS READY**

©2005 SIRIUS Satellite Radio Inc. "SIRIUS", SiriusConnect, the SIRIUS dog logo, channel names and logos are trademarks of SIRIUS Satellite Radio Inc. Available only in the contiguous United States (excluding Alaska and Hawaii) and Canada.

***9**  **XM READY**

XM Ready[®] is a trademark of XM Satellite Radio Inc. ©2005 XM Satellite Radio Inc. All rights reserved.

***10**  **HD Radio**

HD Radio[™] Technology Manufactured Under License From iBiquity Digital Corp. U.S. and Foreign Patents. HD Radio[™] and the HD Radio logo are proprietary trademarks of iBiquity Digital Corp.

***11** Music Optimizer[™] is a trademark of Onkyo Corporation.

***12**  **AUDYSSEY MULTIEQ XT DYNAMIC EQ DYNAMIC VOLUME**

Manufactured under license from Audyssey Laboratories. U.S. and foreign patents pending. Audyssey MultEQ[®] XT, Audyssey Dynamic Volume[™], and Audyssey Dynamic EQ[™] are trademark of Audyssey Laboratories.

THX Ultra2 Plus

Before any home theater component can be THX Ultra2 Plus certified, it must pass a rigorous series of quality and performance tests. Only then can a product feature the THX Ultra2 Plus logo, which is your guarantee that the Home Theater products you purchase will give you superb performance for many years to come. THX Ultra2 Plus requirements define hundreds of parameters, including power amplifier performance, and pre-amplifier performance and operation for both digital and analog domains. THX Ultra2 Plus receivers also feature proprietary THX technologies (e.g., THX Mode) which accurately translate movie soundtracks for home theater playback.

- * “Xantech” is a registered trademark of Xantech Corporation.
- * “Niles” is a registered trademark of Niles Audio Corporation.
- * Apple and iPod are trademarks of Apple Inc., registered in the U.S. and other countries.
- * “x.v.Color” is a trademark of Sony Corporation.

This product incorporates copyright protection technology that is protected by U.S. patents and other intellectual property rights. Use of this copyright protection technology must be authorized by Macrovision Corporation, and is intended for home and other limited consumer uses only unless otherwise authorized by Macrovision. Reverse engineering or disassembly is prohibited.

Multiroom Capability

You can use three speaker systems with this AV controller—a surround-sound speaker system (up to 7.1 channels) in your main listening room, a stereo speaker system in a second room, or Zone 2, as we call it, and another stereo speaker system in a third room that we call Zone 3. And, you can select a different audio source for each room.

Main Room: In your main listening room, you can enjoy up to 7.1-channel playback (see pages 21–25).

You can enjoy the various listening modes such as Dolby, DTS, and THX (see pages 90–100).

Zone 2: In your Zone 2 room, you can enjoy 2-channel stereo playback and video playback (see page 130).

*The listening modes cannot be used with Zone 2 and Zone 3.

*External power amplifier required.

Zone 3: In your Zone 3 room, you can enjoy 2-channel stereo playback (see page 131).

*The listening modes cannot be used with Zone 2 and Zone 3.

*External power amplifier required.

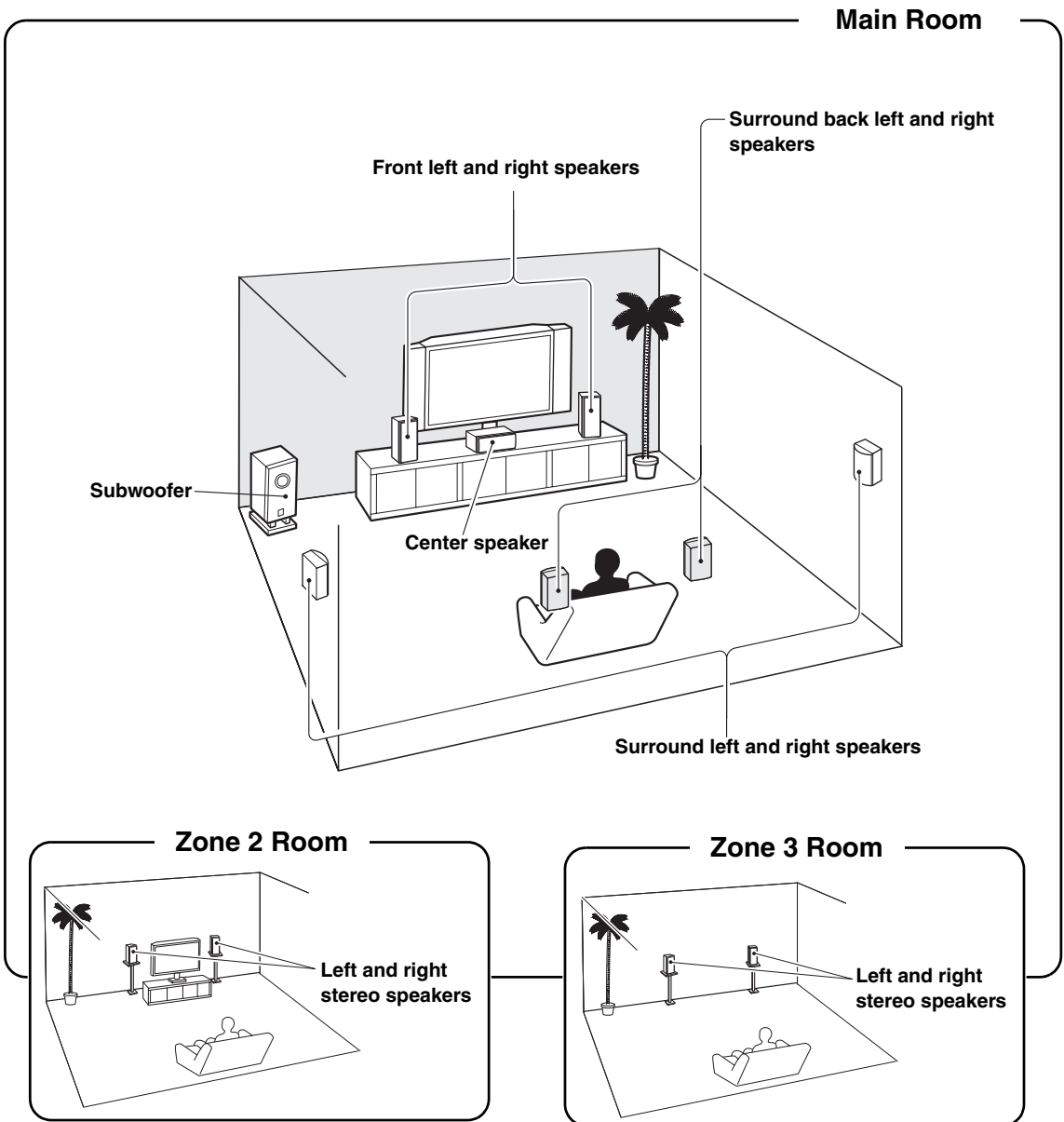

Front & Rear Panels

Front Panel

North American model

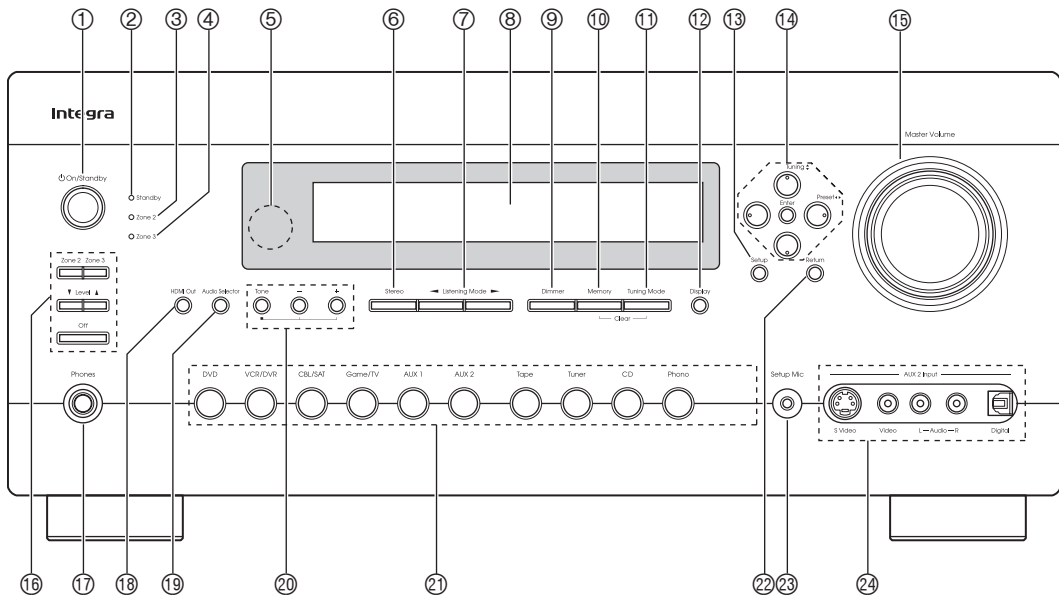

Other models

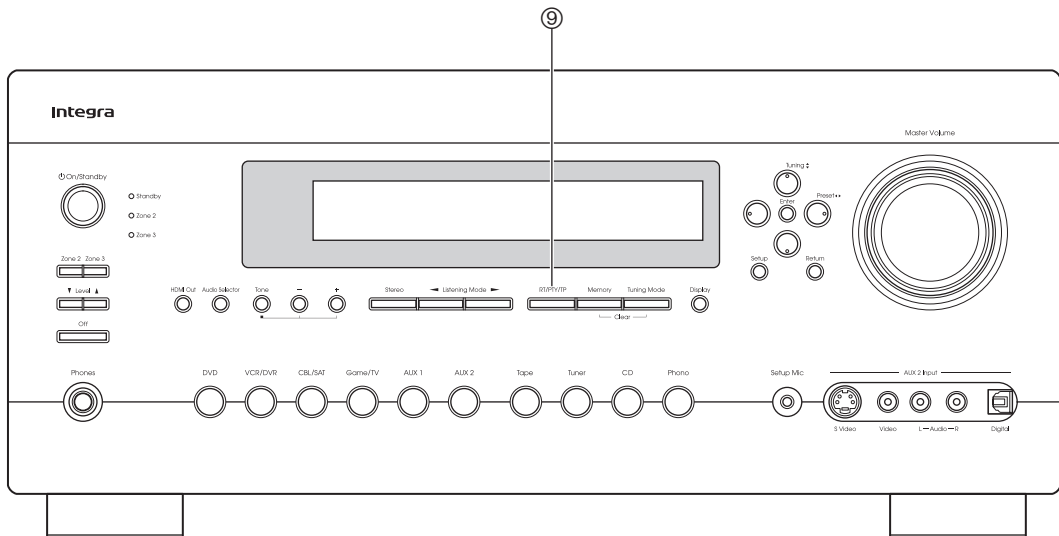

The actual front panel has various logos printed on it. They are not shown here for clarity.

The page numbers in parentheses show where you can find the main explanation for each item.

- ① **On/Standby button (45)**
Sets the AV controller to On or Standby.
- ② **Standby indicator (45)**
Lights up when the AV controller is on Standby and flashes while a signal is being received from the remote controller.
- ③ **Zone 2 indicator (133)**
This indicator lights up when Zone 2 is selected.
- ④ **Zone 3 indicator (133)**
This indicator lights up when Zone 3 is selected.
- ⑤ **Remote-control sensor (15)**
Receives control signals from the remote controller.

- ⑥ **Stereo button (90)**
Selects the Stereo listening mode.
- ⑦ **Listening Mode [◀]/[▶] buttons (90)**
Select the Onkyo original listening modes.
- ⑧ **Display**
See “Display” on page 11.
- ⑨ **Dimmer (RT/PTY/TP) button (65, 73)**
This button is used to adjust the display brightness.
Other models, this is the [RT/PTY/TP] button, and it’s for RDS (Radio Data System). See “Using RDS” on page 72.
- ⑩ **Memory button (69)**
Used when storing or deleting radio presets.
- ⑪ **Tuning Mode button (67)**
Selects the Auto or Manual tuning mode.
- ⑫ **Display button (66)**
Displays various information about the currently selected input source.
- ⑬ **Setup button**
This button is used to access the onscreen setup menus that appear on the connected TV.
- ⑭ **Tuning, Preset, Arrow, and Enter buttons**
When the AM or FM input source is selected, the TUNING [▲]/[▼] buttons are used to tune the tuner, and the PRESET [◀]/[▶] buttons are used to select radio presets (see page 69).

When the onscreen setup menus are used, they work as arrow buttons and are used to select and set items. The [Enter] button is also used with the onscreen setup menus.
- ⑮ **Master Volume control (64)**
Sets the volume of the AV controller to $-\infty$ dB, -81.5 dB through $+18.0$ dB (relative display).
The volume level can also be displayed as an absolute value. See “Volume Setup” on page 123.
- ⑯ **Zone 2, Zone 3, Level [▲]/[▼], and Off buttons (133, 134)**
The Zone 2 button is used when setting Zone 2.
The Zone 3 button is used when setting Zone 3.
The Level Up and Down [▲]/[▼] buttons are used when adjusting the volume level of Zone 2 or Zone 3.
The Off button is used to turn off Zone 2 or Zone 3.
- ⑰ **Phones jack (66)**
This 1/4-inch phone jack is for connecting a standard pair of stereo headphones for private listening.
- ⑱ **HDMI Out button (46)**
Used to set the “Monitor Out” setting.
- ⑲ **Audio Selector button (129)**
Selects the audio input: analog, digital, HDMI, or multichannel.
- ⑳ **Tone, Plus [+], and Minus [-] buttons (66, 134)**
Used to adjust the tone (bass and treble), and the volume and balance of Zone 2 and Zone 3.
- ㉑ **Input selector buttons (64)**
Select the following input sources: DVD, VCR/DVR, CBL/SAT, Game/TV, AUX 1, AUX 2, Tape, Tuner, CD, Phono.
- ㉒ **Return button**
Selects the previously displayed onscreen setup menu.
- ㉓ **Setup Mic (59)**
The included speaker setup microphone is connected here for automatic speaker setup.
- ㉔ **AUX 2 Input (40, 89)**
Used to connect a camcorder, game console, and so on. There are input jacks for optical digital audio, S-Video, composite video, and analog audio.

Display

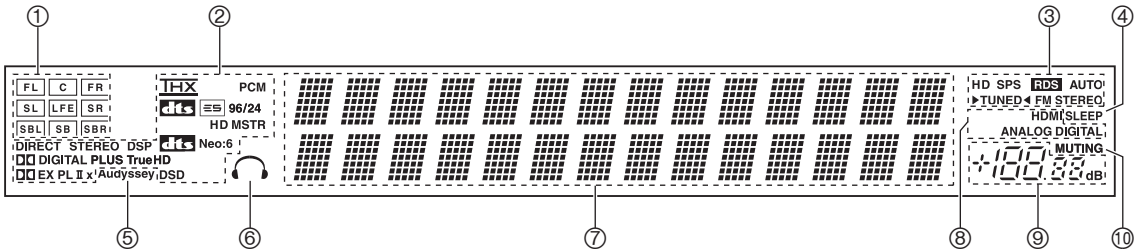

For detailed information, see the pages in parentheses.

① Speaker/channel indicators (97)

Indicate the speaker configuration and channels used by the current input source.

: A box is displayed for each speaker that's set in the Speaker Configuration. No box appears for speakers that are set to No or None.

The following abbreviations indicate which audio channels are included in the current input signal.

- FL:** Front left
- C:** Center
- FR:** Front right
- SL:** Surround left
- LFE:** Subwoofer (Low Frequency Effects)
- SR:** Surround right
- SBL:** Surround back left
- SB:** Surround back
- SBR:** Surround back right

② Listening mode and format indicators (90)

Show the selected listening mode and audio input signal format.

③ Tuning indicators

HD (North American model only) (70): Lights up if the current AM or FM station supports HD Radio technology.

SPS (North American model only) (71): Lights up when tuned to a HD Radio station that's transmitting secondary multicast channels.

RDS (72): Lights up when tuned to a radio station that supports RDS (Radio Data System).

AUTO (67): Lights up when Auto Tuning mode is selected for AM or FM radio. Goes off when Manual Tuning mode is selected.

TUNED (67): Lights up when tuned to a radio station.

FM STEREO (67): Lights up when tuned to a stereo FM station.

④ SLEEP indicator (66)

Lights up when the Sleep function has been set.

⑤ Audyssey indicator (58)

Flashes during automatic speaker setup. Lights up when the "Equalizer Settings" is set to "Audyssey".

⑥ Headphone indicator (66)

Lights up when a pair of headphones are plugged into the Phones jack.

⑦ Message area

Displays various information.

⑧ Audio input indicators (70, 129)

Indicate the type of audio input that's selected as the audio source: HDMI, ANALOG, or DIGITAL.

While a digital HD Radio transmission is being received, the DIGITAL indicator lights up. While an analog HD Radio transmission is being received, the ANALOG indicator lights up.

⑨ Volume level (64)

Displays the volume level.

⑩ MUTE indicator (65)

Flashes while the AV controller is muted.

Rear Panel

North American model

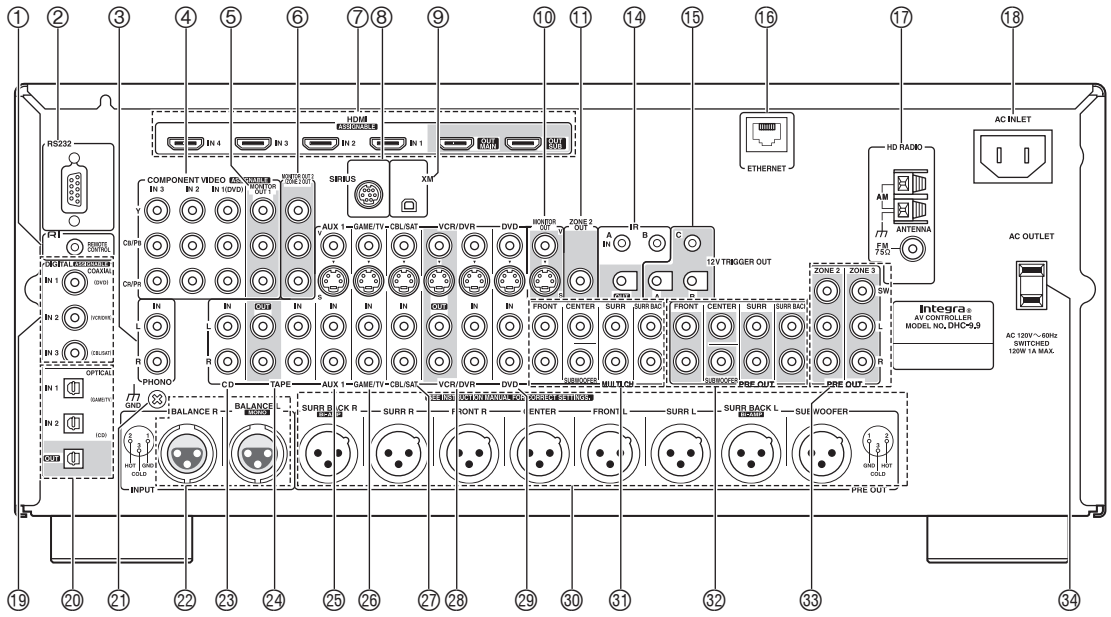

Other models

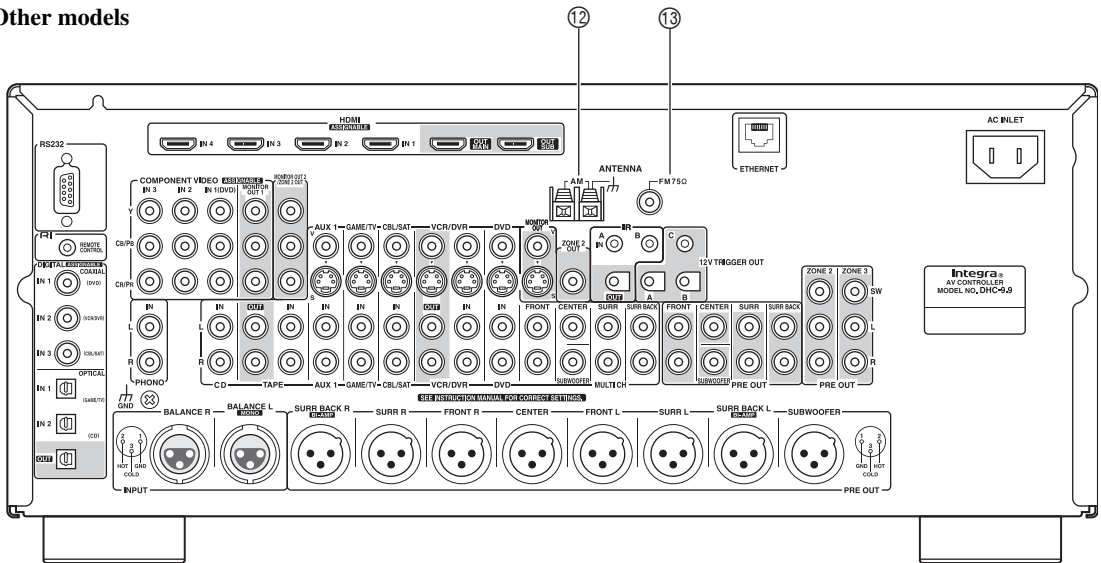

① **RI REMOTE CONTROL**

This **RI** (Remote Interactive) jack can be connected to the **RI** jack on another **RI**-capable Onkyo component for remote and system control.

To use **RI**, you must make an analog audio connection (RCA) between the AV controller and the other component, even if they are connected digitally.

② **RS232**

This port is for connecting the AV controller to home automation equipment and external controllers.

③ **PHONO IN**

This audio input is for connecting a turntable.

④ **COMPONENT VIDEO IN 1, 2, and 3**

These RCA component video inputs are for connecting components with a component video output, such as a DVD player, DVD recorder, or DVR (digital video recorder). They're assignable, which means you can assign each one to an input selector to suit your setup. See "Component Video Setup" on page 52.

⑤ **COMPONENT VIDEO MONITOR OUT 1**

This RCA component video output is for connecting a TV or projector with a component video input.

⑥ **COMPONENT VIDEO MONITOR OUT 2/ZONE 2 OUT**

This RCA component video output is for connecting a TV or projector with a component video input located in your main listening room or Zone 2.

⑦ **HDMI IN 1–4, OUT MAIN, and OUT SUB**

HDMI (High Definition Multimedia Interface) connections carry digital audio and digital video.

The HDMI inputs are for connecting components with an HDMI output, such as a DVD player, DVD recorder, or DVR (digital video recorder). They're assignable, which means you can assign each one to an input selector to suit your setup. See "Video Input Setup" on page 50.

The HDMI outputs are for connecting a TV or projector with an HDMI input.

⑧ **SIRIUS antenna (on North American model)**

This jack is for connecting a SIRIUS digital antenna, sold separately (see the separate SIRIUS instructions).

⑨ **XM antenna (on North American model)**

This jack is for connecting an XM Mini-Tuner and Home Dock, sold separately (see the separate XM instructions).

⑩ **MONITOR OUT**

The S-Video or composite video jack should be connected to a video input on your TV or projector.

⑪ **ZONE 2 OUT**

This composite video output can be connected to a video input on a TV in Zone 2.

⑫ **AM ANTENNA (not North American model)**

These push terminals are for connecting an AM antenna.

⑬ **FM ANTENNA (not North American model)**

This jack is for connecting an FM antenna.

⑭ **IR IN A/B and OUT**

A commercially available IR receiver can be connected to the IR IN A or B jack, allowing you to control the AV controller while you're in Zone 2, or control it when it's out of sight, for example, installed in a cabinet.

A commercially available IR emitter can be connected to the IR OUT jack to pass IR (infrared) remote control signals through to other components.

⑮ **12V TRIGGER OUT (A/B/C)**

These outputs can be connected to the 12-volt trigger inputs on other components.

⑯ **ETHERNET port**

This port is for connecting the AV controller to home automation equipment and external controllers.

Use only shielded Ethernet cables.

⑰ **AM and FM ANTENNA (HD Radio reception) (on North American model)**

The AM push terminals are for connecting an AM antenna. The FM jack is for connecting an FM antenna.

⑱ **AC INLET**

The supplied power cord is connected here. The other end of the power cord should be connected to a suitable wall outlet.

⑲ **DIGITAL COAXIAL IN 1, 2, and 3**

These coaxial digital audio inputs are for connecting components with a coaxial digital audio output, such as a CD player or DVD player. They're assignable, which means you can assign each one to an input selector to suit your setup. See "Digital Audio Input Setup" on page 53.

⑳ **DIGITAL OPTICAL IN 1, 2, and OUT**

These optical digital audio inputs are for connecting components with an optical digital audio output, such as a CD player or DVD player. They're assignable, which means you can assign each one to an input selector to suit your setup. See "Digital Audio Input Setup" on page 53.

The optical digital audio output is for connecting a digital recorder with an optical digital input, such as a CD recorder.

㉑ **GND screw**

This screw is for connecting a turntable's ground wire.

- ②② **BALANCE L/R INPUT**
This balanced XLR input is for connecting a component with a stereo balanced XLR output. For a mono source, connect to the BALANCE L XLR.
- ②③ **CD IN**
This analog audio input is for connecting a CD player's analog audio output.
- ②④ **TAPE IN/OUT**
These analog audio input and output jacks are for connecting a recorder with an analog audio input and output, such as a cassette deck, MD recorder, etc.
- ②⑤ **AUX 1 IN**
A VCR for playback only or other video source can be connected here. There's S-Video and composite video input jacks for connecting the video signal.
- ②⑥ **GAME/TV IN**
A game console or TV output can be connected here. There's S-Video and composite video input jacks for connecting the video signal.
- ②⑦ **CBL/SAT IN**
A cable or satellite receiver can be connected here. There's S-Video and composite video input jacks for connecting the video signal.
- ②⑧ **VCR/DVR IN/OUT**
A video component, such as a VCR or DVR, can be connected here for recording and playback. There's S-Video and composite video input and output jacks for connecting the video signal.
- ②⑨ **DVD IN**
This input is for connecting a DVD player. There's S-Video and composite video input jacks for connecting the video signal.
- ③⑩ **FRONT L/R, CENTER, SURR L/R, SURR BACK L/R and SUBWOOFER PREOUT**
These balanced XLR outputs are for connecting a multichannel power amplifier and powered subwoofer.

The FRONT L/R and SURR BACK L/R outputs can be used with front speakers and surround back speakers, respectively, or used to bi-amp the front speakers. See "Bi-amping the Front Speakers" on page 25.
- ③① **MULTI CH input: FRONT L/R, CENTER, SUBWOOFER, SURR L/R, and SURR BACK L/R**
This analog multichannel input is for connecting a component with a 5.1/7.1-channel analog audio output, such as a DVD player, DVD-Audio or SACD-capable player, or an MPEG decoder.
- ③② **PRE OUT: FRONT L/R, CENTER, SUBWOOFER, SURR L/R, and SURR BACK L/R**
This 5.1/7.1 multichannel analog audio output can be connected to the analog audio input on a multichannel power amplifier. The SUBWOOFER jack is for connecting a powered subwoofer.
- ③③ **PRE OUT: Zone 2, Zone 3**
These analog audio outputs can be connected to the line inputs on amplifiers in Zone 2 and Zone 3. The SW jacks can be connected to the inputs on powered subwoofers in Zone 2 and Zone 3.
- ③④ **AC OUTLET (North American model only)**
These switched AC outlets can be used to supply power to other AV components. The type and number of outlets depends on the country in which you purchased your AV controller.

See pages 21–44 for hookup information.

Remote Controller

Installing the Batteries

- 1 To open the battery compartment, press the small hollow and slide open the cover.**

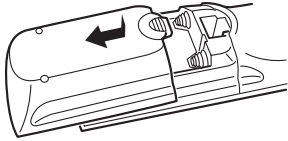

- 2 Insert the three supplied batteries (AA/R6) in accordance with the polarity diagram inside the battery compartment.**

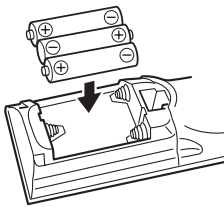

- 3 Slide the cover shut.**

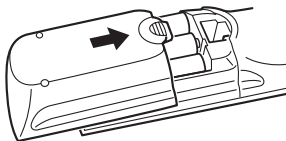

Notes:

- If the remote controller doesn't work reliably, try replacing the batteries.
- Don't mix new and old batteries or different types of batteries.
- If you intend not to use the remote controller for a long time, remove the batteries to prevent damage from leakage or corrosion.
- Expired batteries should be removed as soon as possible to prevent damage from leakage or corrosion.

Aiming the Remote Controller

When using the remote controller, point it toward the AV controller's remote control sensor, as shown below.

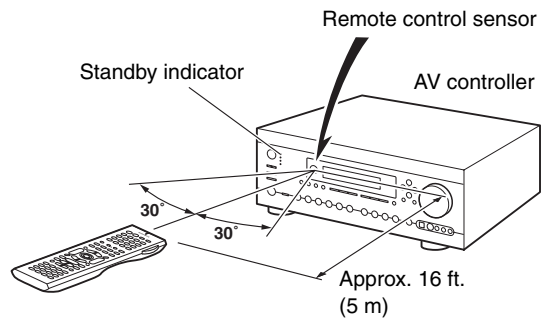

Notes:

- The remote controller may not work reliably if the AV controller is subjected to bright light, such as direct sunlight or inverter-type fluorescent lights. Keep this in mind when installing.
- If another remote controller of the same type is used in the same room, or the AV controller is installed close to equipment that uses infrared rays, the remote controller may not work reliably.
- Don't put anything on top of the remote controller, such as a book or magazine, because a button may be pressed continuously, thereby draining the batteries.
- The remote controller may not work reliably if the AV controller is installed in a rack behind colored glass doors. Keep this in mind when installing.
- The remote controller will not work if there's an obstacle between it and the AV controller's remote control sensor.

About the Remote Controller Modes

As well as the AV controller, you can also use the remote controller to control your other AV components. The remote controller has a specific operating mode for use with each type of component. Modes are selected by using the Remote Mode buttons.

Receiver/Tape Mode

In Receiver/Tape mode, you can control the AV controller and an Onkyo cassette recorder connected via **RI**.

DVD Mode

By default, you can control an Integra/Onkyo DVD player in this mode. By entering the appropriate remote control code, you can control components made by other manufacturers (see page 137).

CD/CDR/MD Mode

By default, you can control an Integra/Onkyo CD player in this mode. By entering the appropriate remote control code, you can control a CD player, MD recorder, or CD recorder made by another manufacturer (see page 137).

Dock Mode

This mode is for controlling an Apple iPod in an Onkyo RI Dock. You must enter the appropriate remote control code first (see page 137).

TV and VCR Modes

With these modes, you can control a TV and VCR. You must enter the appropriate remote control code first (see page 137).

Cable/SAT Mode

In Cable/SAT mode, you can control a cable or satellite TV receiver. You must enter the appropriate remote control code first (see page 137).

Zone 2/Zone 3 Modes

These modes are for controlling Zone 2 and Zone 3 (see page 132).

1 Use the Remote Mode buttons to select a mode.

2 Use the buttons supported by that mode to control the component.

Receiver/Tape mode: see right column

DVD mode: see page 18

CD/CDR/MD mode: see page 19

Dock mode: see page 20

TV, VCR, Cable/SAT modes: see page 139

Receiver/Tape Mode

Receiver/Tape mode is used to control the AV controller. It can also be used to control an Onkyo cassette recorder connected via **RI**.

To set the remote controller to Receiver/Tape mode, press the [Receiver] Remote Mode button.

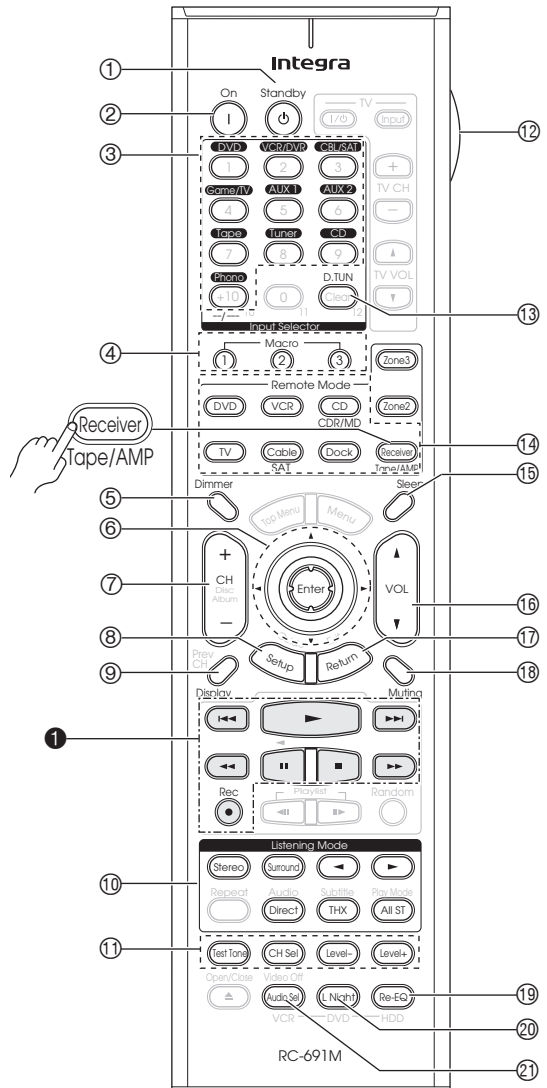

Note:

Some of the remote controller functions described in this manual may not work as expected with other components.

For detailed information, see the pages in parentheses.

- ① **Standby button (45)**
Sets the AV controller to Standby.
- ② **On button (45)**
Turns on the AV controller.
- ③ **Input Selector buttons (64)**
Used to select the input source.
- ④ **Macro buttons (141)**
Used with the Macro function.
- ⑤ **Dimmer button (65)**
Adjusts the display brightness.
- ⑥ **Arrow [▲]/[▼]/[◀]/[▶] and Enter buttons**
Used to select and adjust settings.
- ⑦ **CH +/- button (69)**
Selects radio presets.
- ⑧ **Setup button**
Used to change settings.
- ⑨ **Display button (66)**
Displays information about the current input source.
- ⑩ **Listening Mode buttons (90)**
Used to select the listening modes. The [Stereo], [Surround], and Listening Mode [◀]/[▶] buttons can be used at any time, regardless of the currently selected remote controller mode.
- ⑪ **Test Tone, CH Sel, Level-, and Level+ buttons (65, 108)**
Used to adjust the level of each speaker.
- ⑫ **Light button**
Turns the remote controller's illuminated buttons on or off.
- ⑬ **D.TUN button (68)**
Selects the Direct tuning mode for radio.
- ⑭ **Remote Mode buttons (16)**
Used to select the remote controller modes. When you press a button, the Remote Mode button for the currently selected mode lights up.
- ⑮ **Sleep button (66)**
Used with the Sleep function.
- ⑯ **VOL [▲]/[▼] button (64)**
Adjusts the volume of the AV controller regardless of the currently selected remote controller mode.
- ⑰ **Return button**
Returns to the previous display when changing settings.
- ⑱ **Muting button (65)**
Mutes or unmutes the AV controller.
- ⑲ **Re-EQ button (116)**
Turns the Re-EQ function on or off.
- ⑳ **L Night button (117)**
Turns the Late Night function on or off.

㉑ **Audio Sel button (129)**

Selects the audio input: analog, digital, HDMI, or multichannel.

■ **TAPE mode**

On twin cassette decks, only Deck B can be controlled.

① **Previous and Next [◀◀]/[▶▶] buttons**

The Previous [◀◀] button selects the previous track. During playback it selects the beginning of the current track. The Next [▶▶] button selects the next track.

Depending on how they were recorded, the Previous and Next [◀◀]/[▶▶] buttons may not work properly with some cassette tapes.

Play [▶] button

Starts playback.

Rewind and Fast Forward [◀◀]/[▶▶] buttons

The Rewind [◀◀] button starts rewind. The Fast Forward [▶▶] button starts fast forward.

Reverse Play [◀] button

Starts reverse playback.

Stop [■] button

Stops playback.

Rec [●] button

Starts recording.

DVD Mode

To set the remote controller to DVD mode, press the [DVD] Remote Mode button.

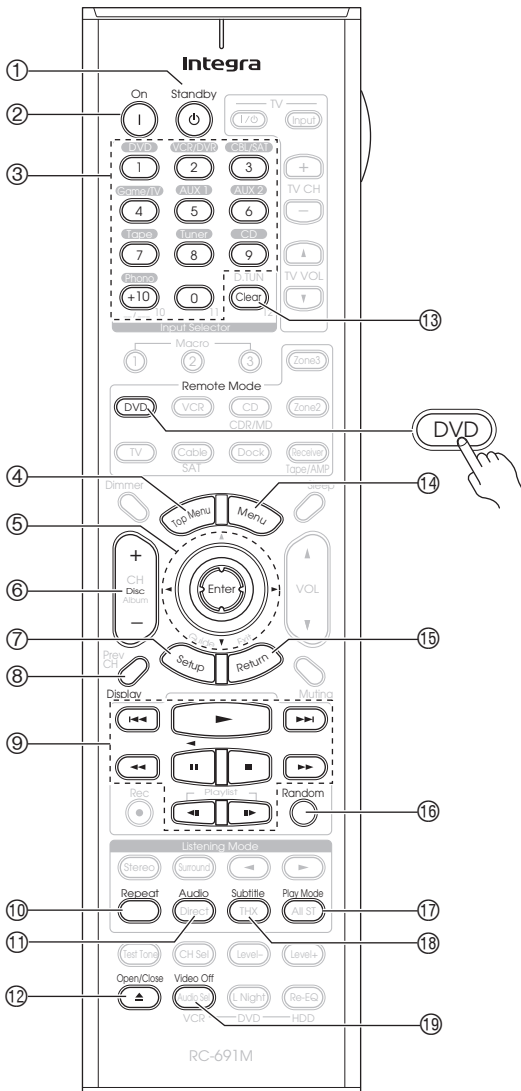

- ① **Standby button**
Sets the DVD player to Standby.
- ② **On button**
Turns on the DVD player.
- ③ **Number buttons**
Used to enter title, chapter, and track numbers, and to enter times for locating specific points.
- ④ **Top Menu button**
Selects a DVD's top menu.
- ⑤ **Arrow [▲]/[▼]/[◀]/[▶] and Enter buttons**
Used to navigate menus and select items.
- ⑥ **Disc +/- button**
Selects discs on a DVD changer.
- ⑦ **Setup button**
Used to access the DVD player's settings.
- ⑧ **Display button**
Displays information about the current disc, title, chapter, or track, including elapsed time, remaining time, total time, and so on.
- ⑨ **Playback buttons**
From left to right: Previous, Play, Next, Fast Reverse, Pause, Stop, Fast Forward, Slow Reverse, and Slow Forward.
- ⑩ **Repeat button**
Used with the repeat playback function.
- ⑪ **Audio button**
Selects foreign language soundtracks and audio formats (e.g., Dolby Digital or DTS).
- ⑫ **Open/Close [▲] button**
Opens and closes the disc tray.
- ⑬ **Clear button**
Cancels functions and clears entered numbers.
- ⑭ **Menu button**
Displays a DVD's menu.
- ⑮ **Return button**
Exits the DVD player's onscreen setup menu.
- ⑯ **Random button**
Used with the random playback function.
- ⑰ **Play Mode button**
Selects play modes on components with selectable play modes.
- ⑱ **Subtitle button**
Selects subtitles.
- ⑲ **Video Off button**
Turns off the internal video circuitry, eliminating any possibility of interference.

CD/CDR/MD Modes

To control an Integra/Onkyo CD player, MD recorder, or CD recorder, or a CD or MD player/recorder made by another manufacturer, press the [CD] Remote Mode button to select the CD/CDR/MD remote controller mode.

In order to control an Onkyo MD recorder or CD recorder, or a component made by another manufacturer, you must first enter the appropriate remote control code (see page 137).

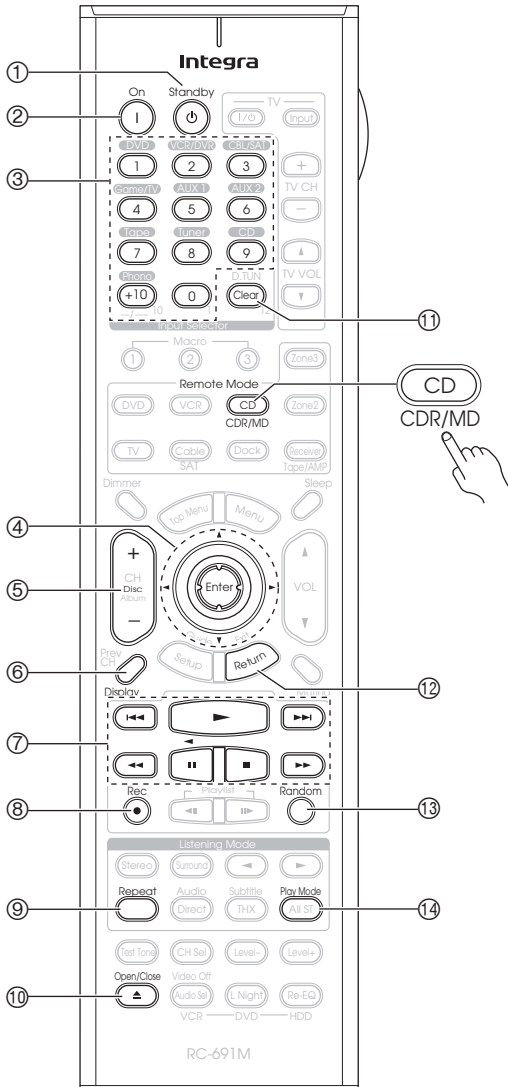

- ① **Standby button**
Sets the component to Standby.
- ② **On button**
Set the component to On or Standby.
- ③ **Number buttons**
Used to enter track numbers and times for locating specific points.
- ④ **Arrow [▲]/[▼]/[◀]/[▶] and Enter buttons**
Used with some components.
- ⑤ **Disc +/- button**
Selects discs on a CD changer.
- ⑥ **Display button**
Displays information about the current disc or track, including elapsed time, remaining time, total time, and so on.
- ⑦ **Playback buttons**
From left to right: Previous, Play, Next, Fast Reverse, Pause, Stop, and Fast Forward.
- ⑧ **Rec [●] button**
Starts recording.
- ⑨ **Repeat button**
Used with the repeat playback function.
- ⑩ **Open/Close [▲] button**
Opens or closes the disc tray or ejects the MiniDisc.
- ⑪ **Clear button**
Cancels functions and clears entered numbers.
- ⑫ **Return button**
Used with some components.
- ⑬ **Random button**
Used with the random playback function.
- ⑭ **Play Mode button**
Selects play modes on components with selectable play modes.

Dock Mode

Dock mode is for controlling an Apple iPod in an Onkyo RI Dock.

To control an RI Dock, press the [Dock] Remote Mode button to select the Dock remote controller mode.

In order to control an RI Dock, you must first enter the appropriate remote control code (see page 137).

When Using an RI Dock:

- Connect the RI Dock to the TAPE IN or AUX 1 IN L/R jacks.
- Set the RI Dock's RI MODE switch to HDD or HDD/DOCK.
- Set the AV controller's Input Display to "DOCK" (see page 57).
- See to the RI Dock's instruction manual for more information.

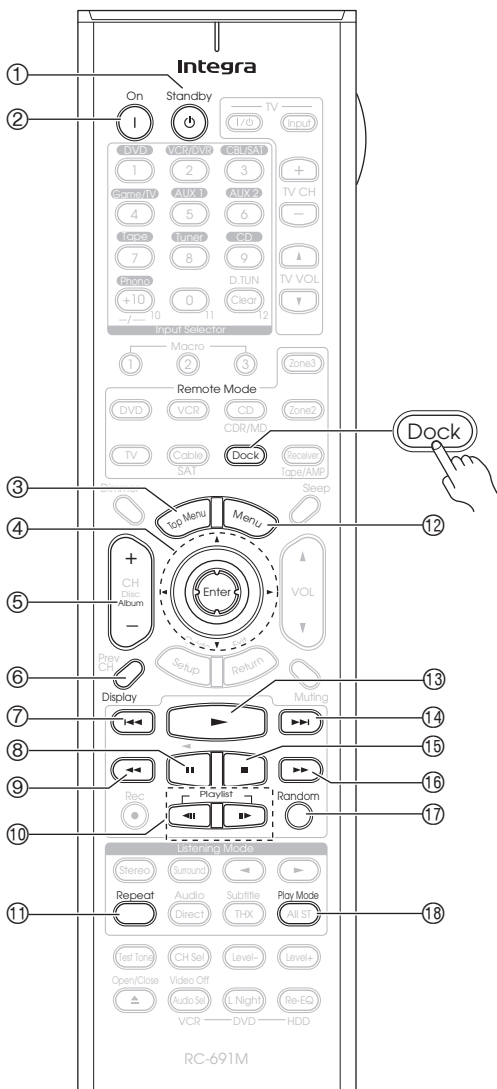

- Standby button**
Turns off the iPod.
- On button***
Turns on the iPod.
- Top Menu button**
Works as a Mode button when used with a DS-A2 RI Dock.
- Arrow [▲]/[▼] and Enter buttons***
Used to navigate menus and select items.
- Album +/- button***
Selects the next or previous album.
- Display button***
Turns on the backlight for 30 seconds.
- Previous [◀◀] button**
Restarts the current song. Press it twice to select the previous song.
- Pause [||] button**
Pauses playback. (With 3rd generation iPods, it works as a Play/Pause button.)
- Fast Reverse [◀◀] button**
Press and hold to fast reverse.
- Playlist Up/Down [◀||]/[||▶] buttons***
Used to select the previous or next playlist on the iPod.
- Repeat button***
Used with the repeat function.
- Menu button***
Used to access menus.
- Play [▶▶] button**
Starts playback. If the component is off, it will turn on automatically. (With 3rd generation iPods, this button works as a Play/Pause button.)
- Next [▶▶▶] button**
Selects the next song.
- Stop [■] button**
Stops playback and displays a menu.
- Fast Forward [▶▶▶] button**
Press and hold to fast forward.
- Random button***
Used with the shuffle function.
- Play Mode button**
Used to select play modes on components with selectable play modes. Works as a Resume button when used with a DS-A2 RI Dock.

* Buttons marked with an asterisk (*) are not supported by 3rd generation iPods.

About Home Theater

Enjoying Home Theater

Thanks to the AV controller's superb capabilities, you can enjoy surround sound with a real sense of movement in your own home—just like being in a movie theater or concert hall. With DVDs you can enjoy DTS and Dolby Digital. With analog or digital TV, you can enjoy Dolby Pro Logic IIX, DTS Neo:6, or Onkyo's original DSP listening modes. You can also enjoy THX Surround EX (THX-certified THX speaker system recommended).

Front left and right speakers

These output the main sound. Their role in a home theater is to provide a solid anchor for the sound image. They should be positioned facing the listener at about ear level, and equally spaced from the TV. Angle them inward slightly so as to create a triangle, with the listener at the apex.

Surround left and right speakers

These speakers are used for precise sound positioning and to add realistic ambience.

Position them at the sides of the listener, or slightly behind, about 2–3 feet (60–100 cm) above ear level. Ideally they should be equally spaced from the listener.

Center speaker

This speaker enhances the front left and right speakers, making sound movements distinct and providing a full sound image. For movies it's used mainly for dialog.

Position it close to your TV (preferably on top) facing forward at about ear level, or at the same height as the front left and right speakers.

Subwoofer

The subwoofer handles the bass sounds of the LFE (Low-Frequency Effects) channel. The volume and quality of the bass output from your subwoofer will depend on its position, the shape of your listening room, and your listening position. In general, a good bass sound can be obtained by installing the subwoofer in a front corner, or at one-third the way along the front wall, as shown.

Tip: To find the best position for your subwoofer, while playing a movie or some music with good bass, experiment by placing your subwoofer at various positions within the room and choose the one that provides the most satisfying results.

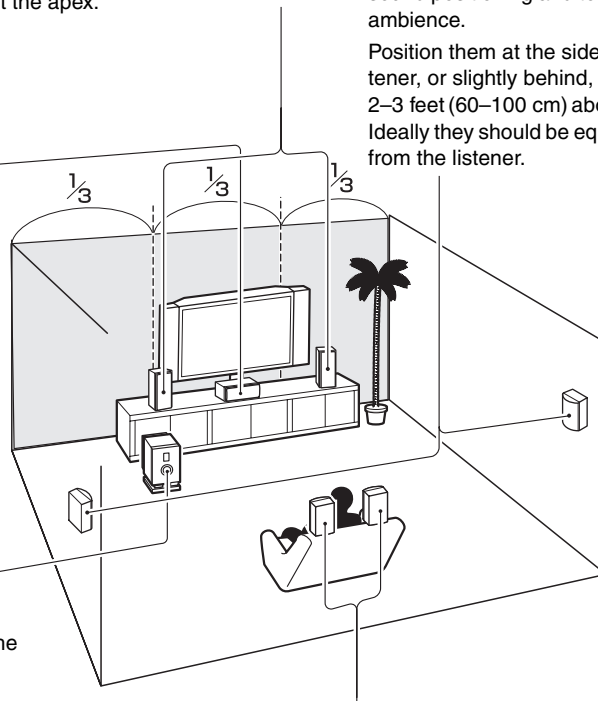

Surround back left and right speakers

These speakers are necessary to enjoy Dolby Digital EX, DTS-ES Matrix, DTS-ES Discrete, THX Surround EX, etc. They enhance the realism of surround sound and improve sound localization behind the listener. Position them behind the listener about 2–3 feet (60–100 cm) above ear level.

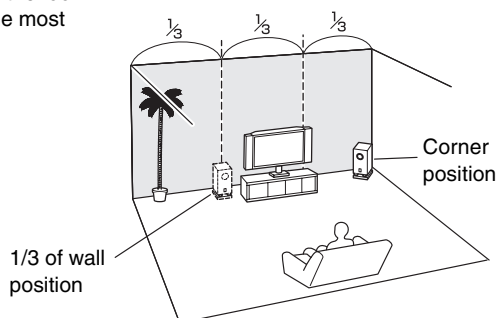

Connecting the AV Controller

Connecting Your Speakers

The AV controller is designed to be used with a separate multichannel power amplifier. You connect the AV controller's PRE OUT jacks to the amplifier's inputs, and connect your speakers to the amplifier's speakers terminals. Speaker settings such as crossover frequency and distance are set on the AV controller.

Speaker Configuration

For 7.1-channel surround-sound playback, you need seven speakers and a powered subwoofer.

The following table shows which channels you should use based on the number of speakers you have.

Number of speakers:	2	3	4	5	6	7
Front left	✓	✓	✓	✓	✓	✓
Front right	✓	✓	✓	✓	✓	✓
Center		✓		✓	✓	✓
Surround left			✓	✓	✓	✓
Surround right			✓	✓	✓	✓
Surround back*					✓	
Surround back left						✓
Surround back right						✓

* If you're using only one surround back speaker, use the SURR BACK L output.

No matter how many speakers you use, a powered subwoofer is recommended for a powerful and solid bass.

To get the best from your surround-sound system, you must set the speaker settings. You can do this automatically (see page 58) or manually (see page 104).

Using Dipole Speakers

You can use dipole speakers for the surround left and right and surround back left and right speakers. Dipole speakers output the same sound in two directions.

Dipole speakers typically have an arrow printed on them to indicate how they should be positioned. The surround left and right dipole speakers should be positioned so that their arrows point toward your TV or screen, while the surround back left and right dipolar speakers should be positioned so that their arrows point toward each other, as shown.

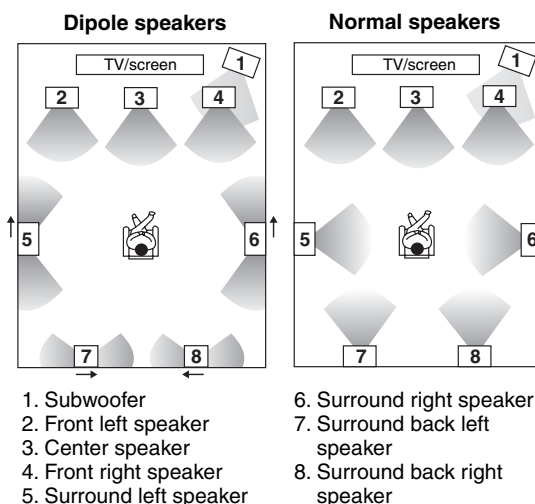

Connecting the AV Controller—Continued

Connecting a Powered Subwoofer

Using a suitable cable, connect the AV controller's SUBWOOFER PRE OUT to the input on your powered subwoofer. If your subwoofer is unpowered and you're using an external amplifier, connect the SUBWOOFER PRE OUT to the amp's input.

You can also connect a powered subwoofer to the AV controller's balanced SUBWOOFER PRE OUT XLR jack by using a balanced XLR cable.

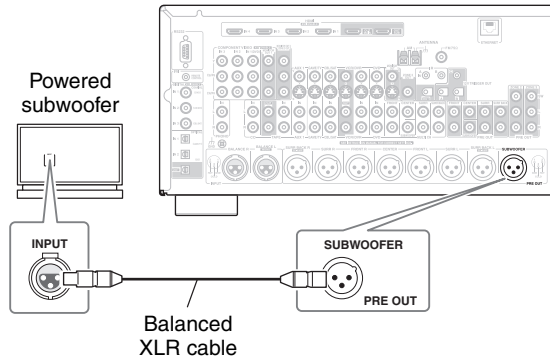
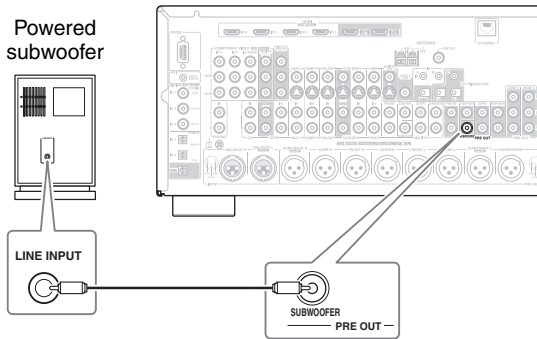

Connecting a Power Amplifier with RCA Inputs

You can connect the AV controller to a multichannel power amplifier with RCA input jacks by using a multichannel RCA audio cable or several stereo RCA audio cables.

See your multichannel power amplifier's instruction manual for more information on connecting speakers.

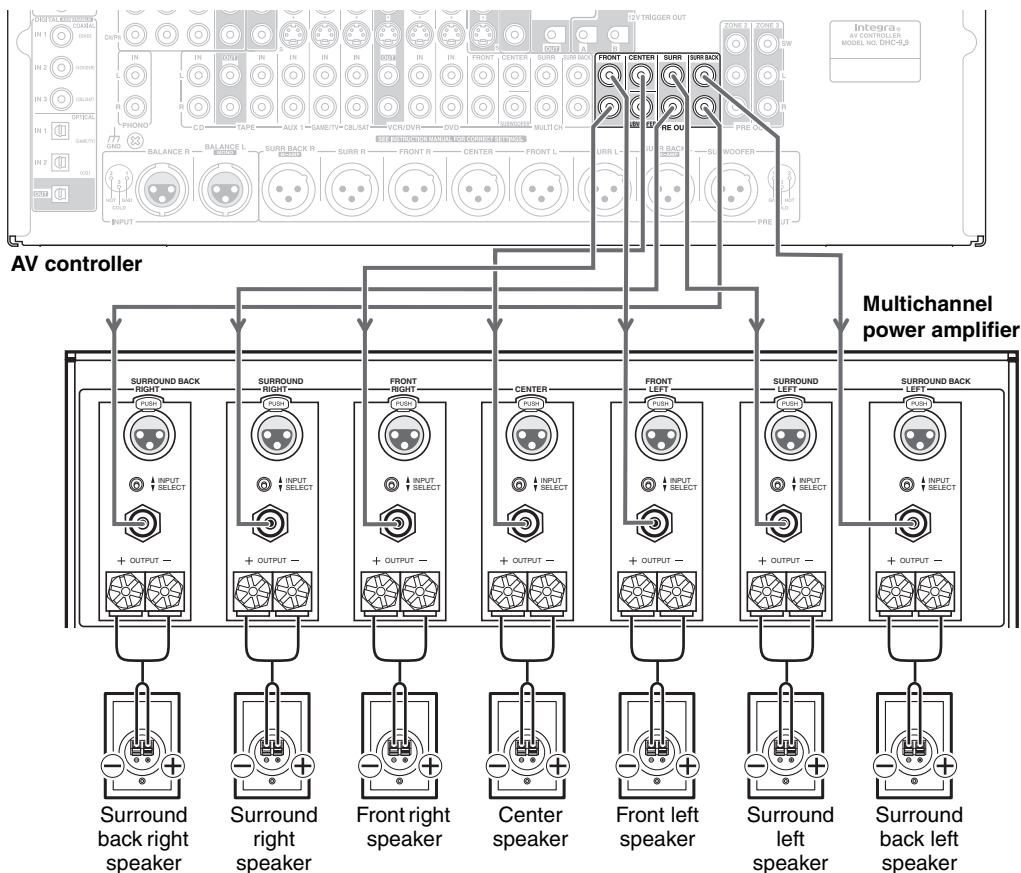

Connecting the AV Controller—Continued

Connecting a Power Amplifier with XLR Inputs

You can connect the AV controller to a multichannel power amplifier with balanced XLR input jacks by using several XLR audio cables.

The AV controller's balanced PRE OUT XLR jacks are wired as shown.

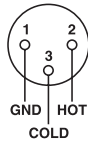

See your multichannel power amplifier's instruction manual for more information on connecting speakers.

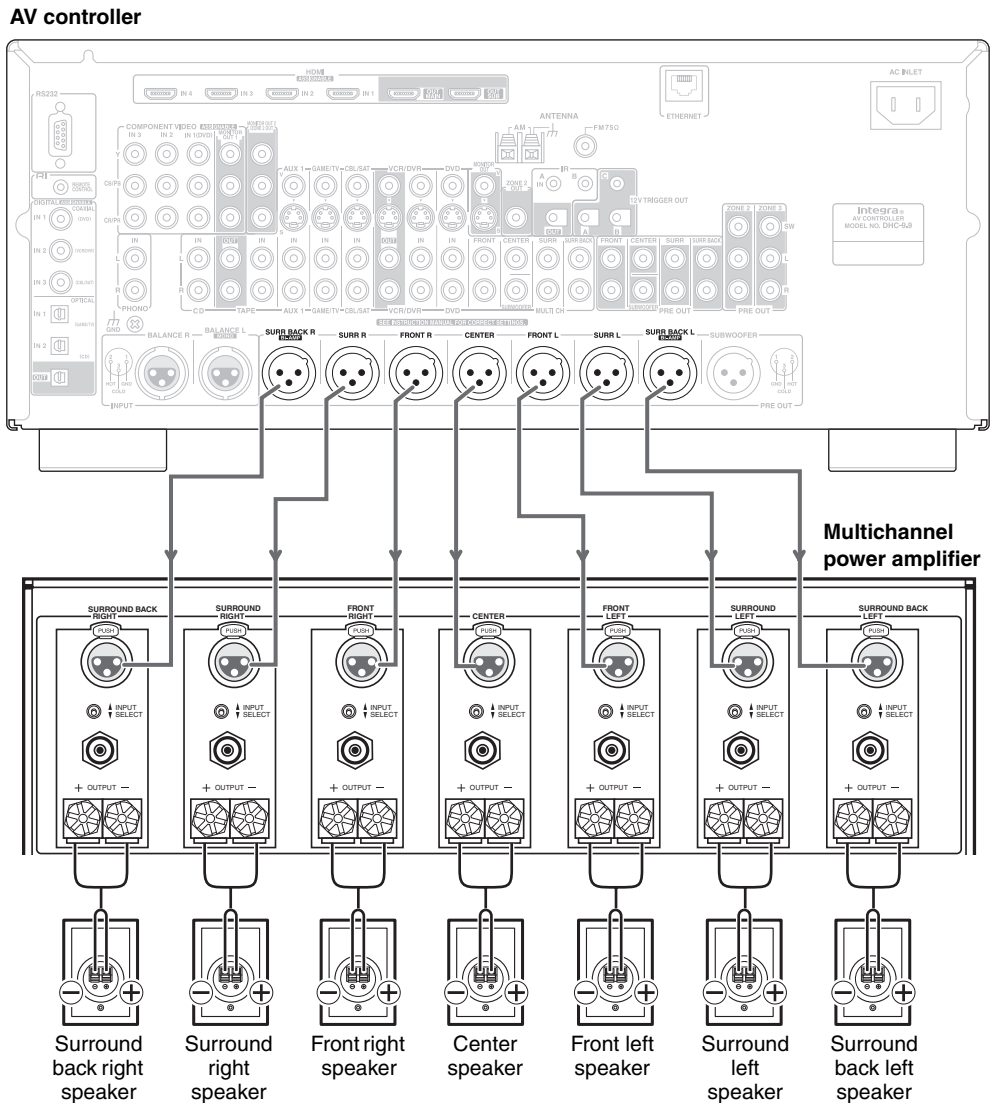

Connecting the AV Controller—Continued

Bi-amping the Front Speakers

The FRONT L/R and SURR BACK L/R outputs can be used with front speakers and surround back speakers, respectively, or bi-amped to provide separate tweeter and woofer feeds for a pair of front speakers that support bi-amping, providing improved bass and treble performance.

- When bi-amping is used, the AV controller is able to feed up to 5.1 speakers in the main room.
- For bi-amping, the FRONT L/R outputs feed the front speakers' woofer terminals. And the SURR BACK L/R outputs feed the front speakers' tweeter terminals.
- Once you've completed the bi-amping connections shown below and turned on the AV controller, you must set the "Speaker Type" setting to "Bi-Amp" to enable bi-amping (see page 55).

Important:

- **When making the bi-amping connections, be sure to remove the jumper bars that link the speakers' tweeter (high) and woofer (low) terminals.**
- Bi-amping can only be used with speakers that support bi-amping. Refer to your speaker manual.

See your multichannel power amplifier's instruction manual for more information on connecting speakers.

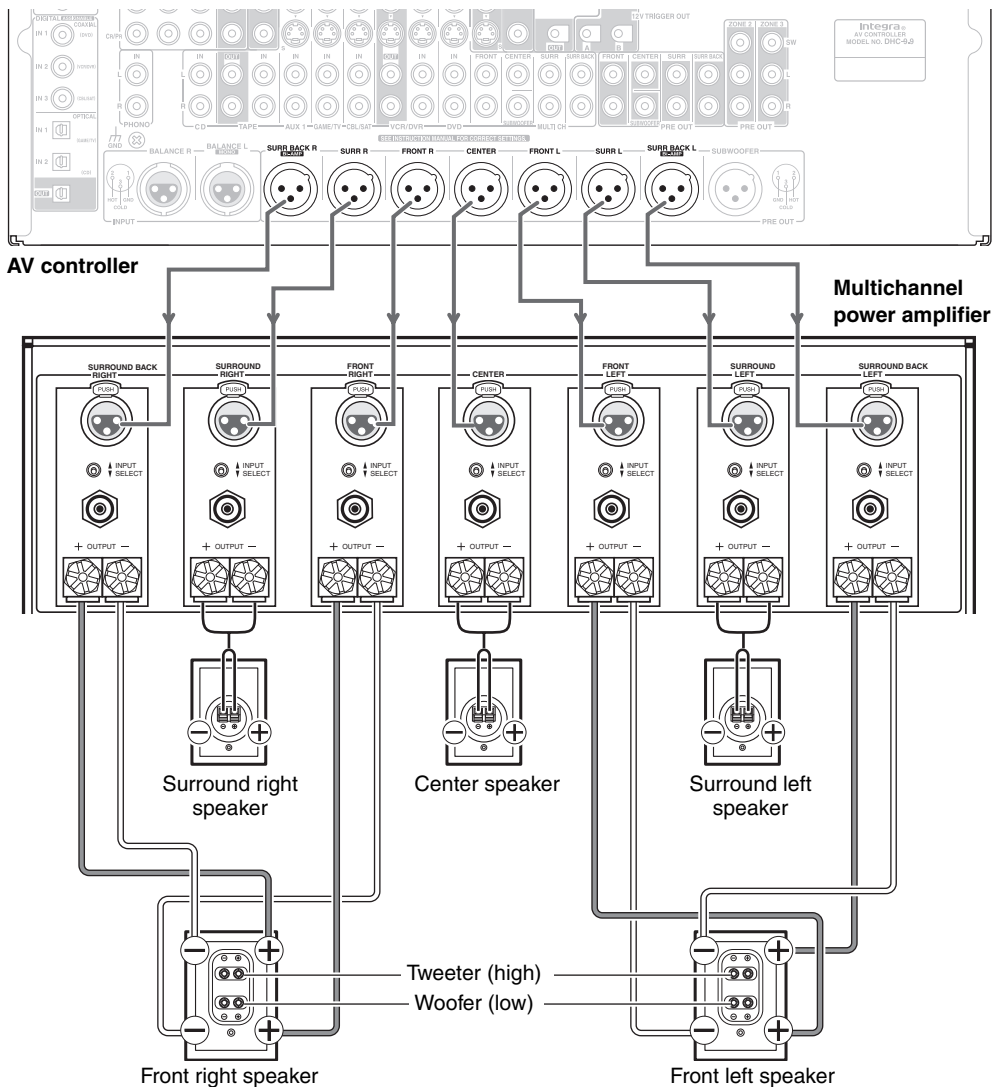

Connecting Antenna

This section explains how to connect the supplied indoor FM antenna and AM loop antenna, and how to connect commercially available outdoor FM and AM antennas.

The AV controller won't pick up any radio signals without any antenna connected, so you must connect the antenna to use the tuner.

■ North American Model

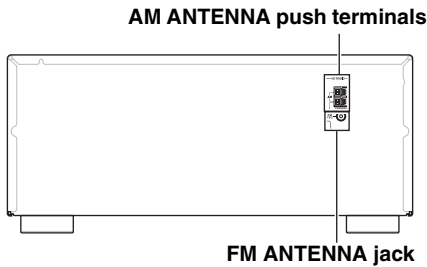

■ Other Models

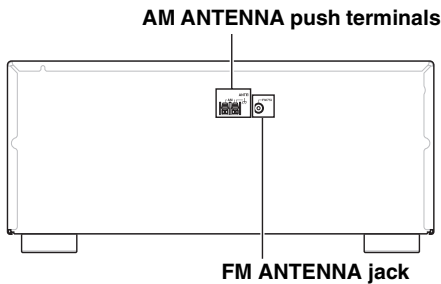

Connecting the Indoor FM Antenna

The supplied indoor FM antenna is for indoor use only.

1 Attach the FM antenna, as shown.

■ North American Model

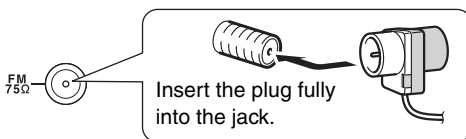

■ Other Models

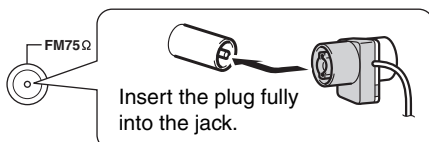

Once your AV controller is ready for use, you'll need to tune into an FM radio station and adjust the position of the FM antenna to achieve the best possible reception.

2 Use thumbtacks or something similar to fix the FM antenna into position.

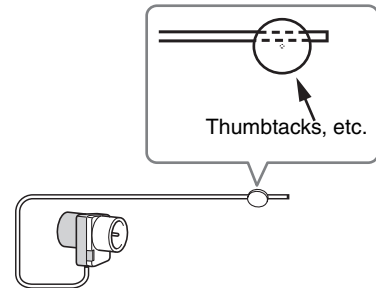

Caution: Be careful that you don't injure yourself when using thumbtacks.

If you cannot achieve good reception with the supplied indoor FM antenna, try a commercially available outdoor FM antenna instead (see page 27).

Connecting the AM Loop Antenna

The supplied indoor AM loop antenna is for indoor use only.

1 Assemble the AM loop antenna, inserting the tabs into the base, as shown.

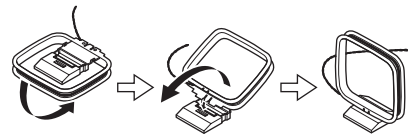

2 Connect both wires of the AM loop antenna to the AM push terminals, as shown.

(The antenna's wires are not polarity sensitive, so they can be connected either way around).

Make sure that the wires are attached securely and that the push terminals are gripping the bare wires, not the insulation.

■ North American Model

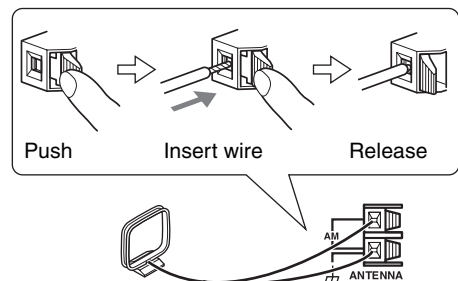

Connecting the AV Controller—Continued

Other Models

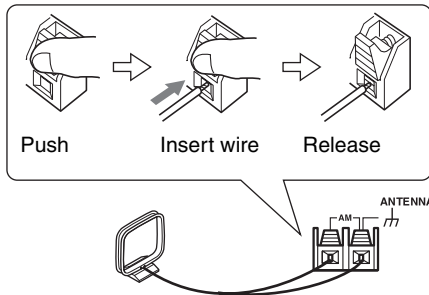

Once your AV controller is ready for use, you'll need to tune into an AM radio station and adjust the position of the AM antenna to achieve the best possible reception.

Keep the antenna as far away as possible from your AV controller, TV, speaker cables, and power cords.

If you cannot achieve good reception with the supplied indoor AM loop antenna, try using it with a commercially available outdoor AM antenna (see page 27).

Connecting an Outdoor FM Antenna

If you cannot achieve good reception with the supplied indoor FM antenna, try a commercially available outdoor FM antenna instead.

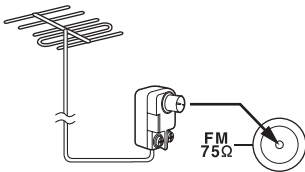

Notes:

- Outdoor FM antennas work best outside, but usable results can sometimes be obtained when installed in an attic or loft.
- For best results, install the outdoor FM antenna well away from tall buildings, preferably with a clear line of sight to your local FM transmitter.
- Outdoor antenna should be located away from possible noise sources, such as neon signs, busy roads, etc.
- For safety reasons, outdoor antenna should be situated well away from power lines and other high-voltage equipment.
- Outdoor antenna must be grounded in accordance with local regulations to prevent electrical shock hazards.

Using a TV/FM Antenna Splitter

It's best not to use the same antenna for both FM and TV reception, as this can cause interference problems. If circumstances demand it, use a TV/FM antenna splitter, as shown.

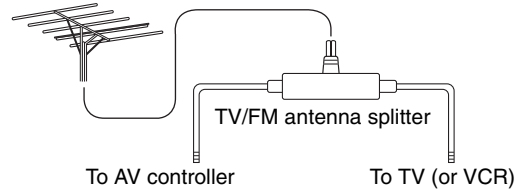

Connecting an Outdoor AM Antenna

If good reception cannot be achieved using the supplied AM loop antenna, an outdoor AM antenna can be used in addition to the loop antenna, as shown.

North American Model

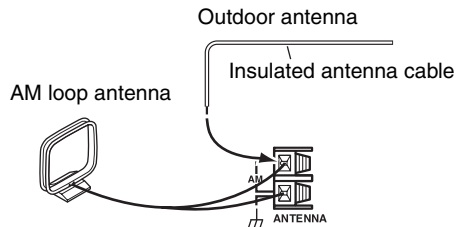

Other Models

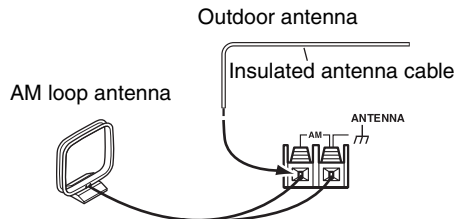

Outdoor AM antennas work best when installed horizontally outside, but good results can sometimes be obtained indoors by mounting horizontally above a window. Note that the AM loop antenna should be left connected.

Outdoor antenna must be grounded in accordance with local regulations to prevent electrical shock hazards.

Connecting the AV Controller—Continued

About AV Connections

- Before making any AV connections, read the manuals supplied with your other AV components.
- Don't connect the power cord until you've completed and double-checked all AV connections.

Optical Digital Jacks

The AV controller's optical digital jacks have shutter-type covers that open when an optical plug is inserted and close when it's removed. Push plugs in all the way.

Caution: To prevent shutter damage, hold the optical plug straight when inserting and removing.

AV Connection Color Coding

RCA-type AV connections are usually color coded: red, white, and yellow. Use red plugs to connect right-channel audio inputs and outputs (typically labeled "R"). Use white plugs to connect left-channel audio inputs and outputs (typically labeled "L"). And use yellow plugs to connect composite video inputs and outputs.

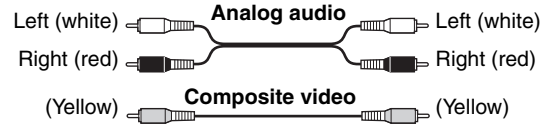

- Push plugs in all the way to make good connections (loose connections can cause noise or malfunctions).
- To prevent interference, keep audio and video cables away from power cords and speaker cables.

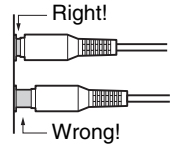

AV Cables and Jacks

Video

Cable	Jack	Description
		HDMI connections can carry uncompressed standard- or high-definition digital video and audio and offer the best picture and sound quality.
		Component video separates the luminance (Y) and color difference signals (PR, PB), providing the best picture quality. (Some TV manufacturers label their component video jacks slightly differently.)
		S-Video separates the luminance and color signals and provides better picture quality than composite video.
		Composite video is commonly used on TVs, VCRs, and other video equipment.

Audio

		This offers the best sound quality and allows you to enjoy Dolby Digital and DTS. The audio quality is the same as for coaxial.
		This offers the best sound quality and allows you to enjoy Dolby Digital and DTS. The audio quality is the same as for optical.
		This cable carries analog audio. Balanced XLR cables are used for better noise immunity and longer cable runs.
		This cable carries analog audio. It's the most common connection format for analog audio and can be found on virtually all AV components.
		This cable carries multichannel analog audio and is typically used to connect DVD players with a 7.1-channel analog audio output. Several standard analog audio cables can be used instead of a multi-channel cable.

Note: The AV controller does not support SCART connections.

Connecting the AV Controller—Continued

Connecting Both Audio & Video

By connecting both the audio and video outputs of your DVD player and other AV components to the AV controller, you can switch the audio and video signals simultaneously simply by changing the input source on the AV controller.

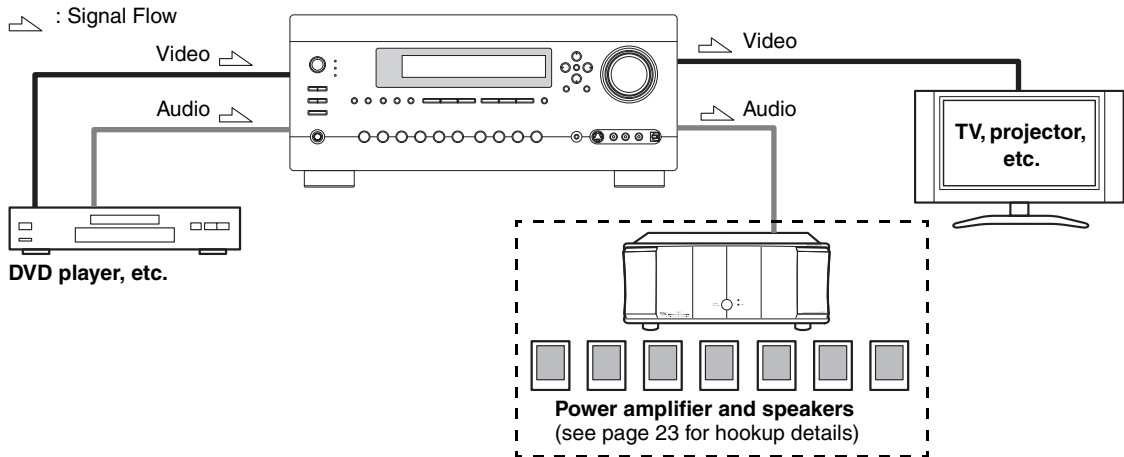

Which Connections Should I Use?

The AV controller supports several connection formats for compatibility with a wide range of AV equipment. The format you choose will depend on the formats supported by your other components. Use the following sections as a guide.

For video components, you must make an audio connection and a video connection.

Video Connection Formats

Video equipment can be connected to the AV controller by using any one of the following video connection formats: composite video, S-Video, component video, or HDMI, the latter offering the best picture quality.

The AV controller can upconvert and downconvert between video formats, depending on the "Monitor Out" setting, which generally determines whether video signals are upconverted for the component video output or the HDMI outputs.

For optimal video performance, THX recommends that video signals pass through the system without upconversion (e.g., component video input through to component video output). It's also recommended that you set the "Immediate Display" preference to "Off" (see page 124), the "Picture Adjust" setting to the default (see page 119), and the "Resolution" setting to "Through" (see pages 49, 50).

■ "Monitor Out" Setting Set to "HDMI Main" or "HDMI Sub"

With the "Monitor Out" setting set to "HDMI Main" or "HDMI Sub" (see page 49), video input signals flow through the AV controller as shown, with composite video, S-Video, and component video sources all being upconverted for the respective HDMI output. Use the "HDMI Main" or "HDMI Sub" setting if you connect the AV controller's HDMI OUT MAIN or HDMI OUT SUB, respectively, to your TV.

The composite video, S-Video, and component video outputs pass through their respective input signals as they are.

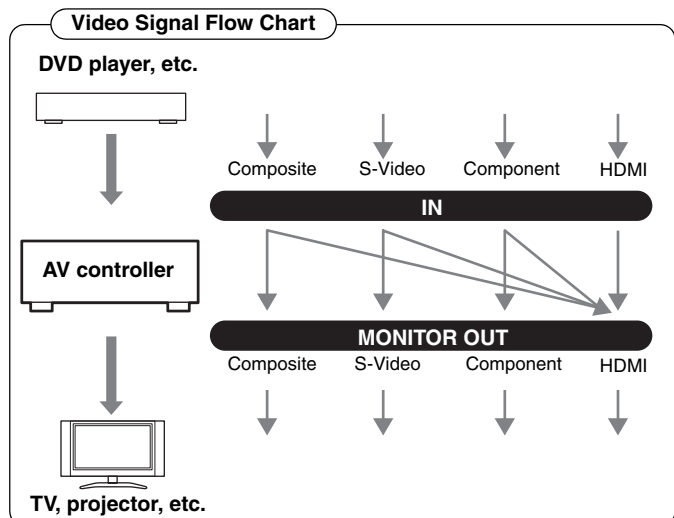

Connecting the AV Controller—Continued

■ “Monitor Out” Setting Set to “Analog”

With the “Monitor Out” setting set to “Analog” (see page 49), video input signals flow through the AV controller as shown, with composite video and S-Video sources being upconverted for the component video output. Use this setting if you connect the AV controller’s COMPONENT VIDEO MONITOR OUT 1 or 2 to your TV.

Composite video is upconverted to S-Video and S-Video is downconverted to composite video. Note that these conversions only apply to the MONITOR OUT V and S outputs, not the VCR/DVR OUT V and S outputs.

The composite video, S-Video, and component video outputs pass through their respective input signals as they are.

This signal flow also applies when the Monitor Out “Resolution” setting is set to “Through” (see pages 49, 50).

Video Signal Flow and the Resolution Setting

When the “Monitor Out” setting is set to “Analog” (see page 49), if the Monitor Out “Resolution” setting is set to anything other than “Through” (see pages 49, 50), the video signal flow will be as shown here, with composite video and S-Video sources being upconverted for the component video output.

The composite video, S-Video, and component video outputs pass through their respective analog input signals as they are. HDMI input signals are not output.

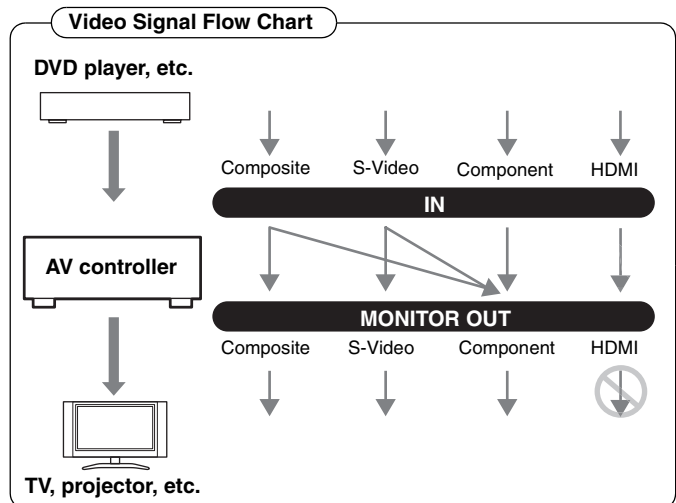
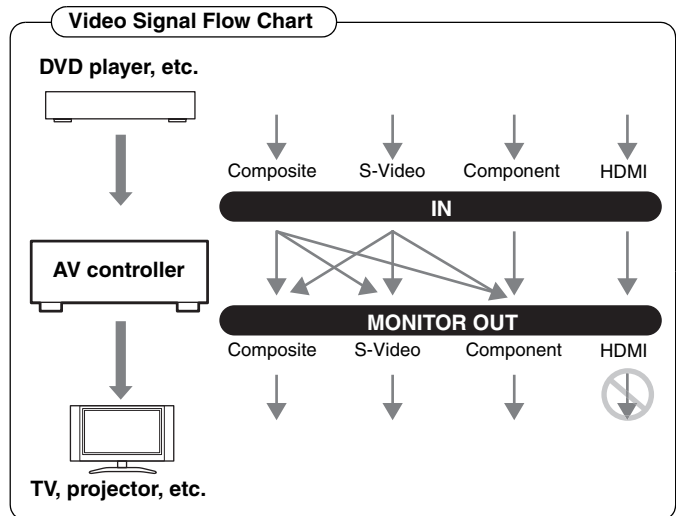

Audio Connection Formats

Audio equipment can be connected to the AV controller by using any of the following audio connection formats: analog, optical, coaxial, analog multichannel, or HDMI.

When choosing a connection format, bear in mind that the AV controller does not convert digital input signals for analog line outputs and vice versa. For example, audio signals connected to an optical or coaxial digital input are not output by the analog TAPE OUT.

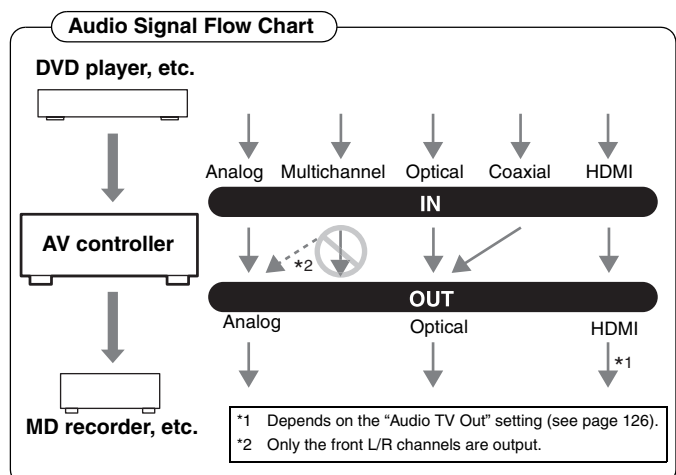

Connecting the AV Controller—Continued

Connecting a TV or Projector

See “Connecting Components with HDMI” on page 37 for HDMI connection information.

Step 1: Video Connection

Choose a video connection that matches your TV (**A**, **B**, or **C**), and then make the connection.

Step 2: Audio Connection

Choose an audio connection that matches your TV (**a**, **b**, or **c**), and then make the connection.

- With connection **a**, you can listen to and record audio from your TV or listen in Zone 2 or Zone 3.
- To enjoy Dolby Digital and DTS, use connection **b** or **c**. (To record or listen in Zone 2 or Zone 3 as well, use **a** and **b**, or **a** and **c**.)

Connection	AV controller	Signal flow	TV
A	COMPONENT VIDEO MONITOR OUT 1	⇒	Component video input
B	MONITOR OUT S	⇒	S-Video input
C	MONITOR OUT V	⇒	Composite video input
a	GAME/TV IN L/R	←	Analog audio L/R output
b	DIGITAL COAXIAL IN 2 (VCR/DVR)	←	Digital coaxial output
c	DIGITAL OPTICAL IN 1 (GAME/TV)	←	Digital optical output

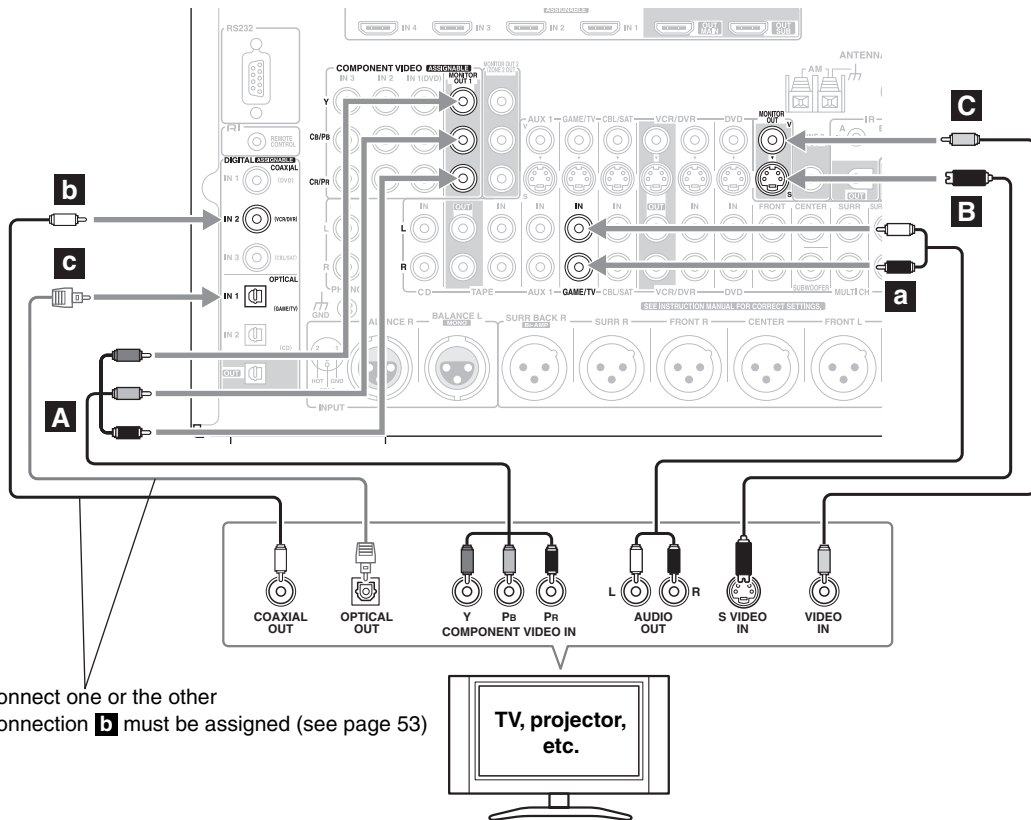

Connect one or the other
Connection **b** must be assigned (see page 53)



If your TV has no audio outputs, connect an audio output from your VCR or cable or satellite receiver to the AV controller and use its tuner to listen to TV programs through the AV controller (see pages 34 and 36).

Connecting the AV Controller—Continued

Connecting a DVD player

Step 1: Video Connection

Choose a video connection that matches your DVD player (**A**, **B**, or **C**), and then make the connection. If you use connection **A**, you must connect the AV controller to your TV with the same type of connection.

Step 2: Audio Connection

Choose an audio connection that matches your DVD player (**a**, **b**, or **c**), and then make the connection.

- With connection **a**, you can listen to and record audio from a DVD or listen in Zone 2 or Zone 3.
- To enjoy Dolby Digital and DTS, use connection **b** or **c**. (To record or listen in Zone 2 or Zone 3 as well, use **a** and **b**, or **a** and **c**.)
- If your DVD player has main left and right outputs and multichannel left and right outputs, be sure to use the main left and right outputs for connection **a**.

Connection	AV controller	Signal flow	DVD player
A	COMPONENT VIDEO IN 1 (DVD)	←	Component video output
B	DVD IN S	←	S-Video output
C	DVD IN V	←	Composite video output
a	DVD IN L/R	←	Analog audio L/R output
b	DIGITAL COAXIAL IN 1 (DVD)	←	Digital coaxial output
c	DIGITAL OPTICAL IN 1 (GAME/TV)	←	Digital optical output

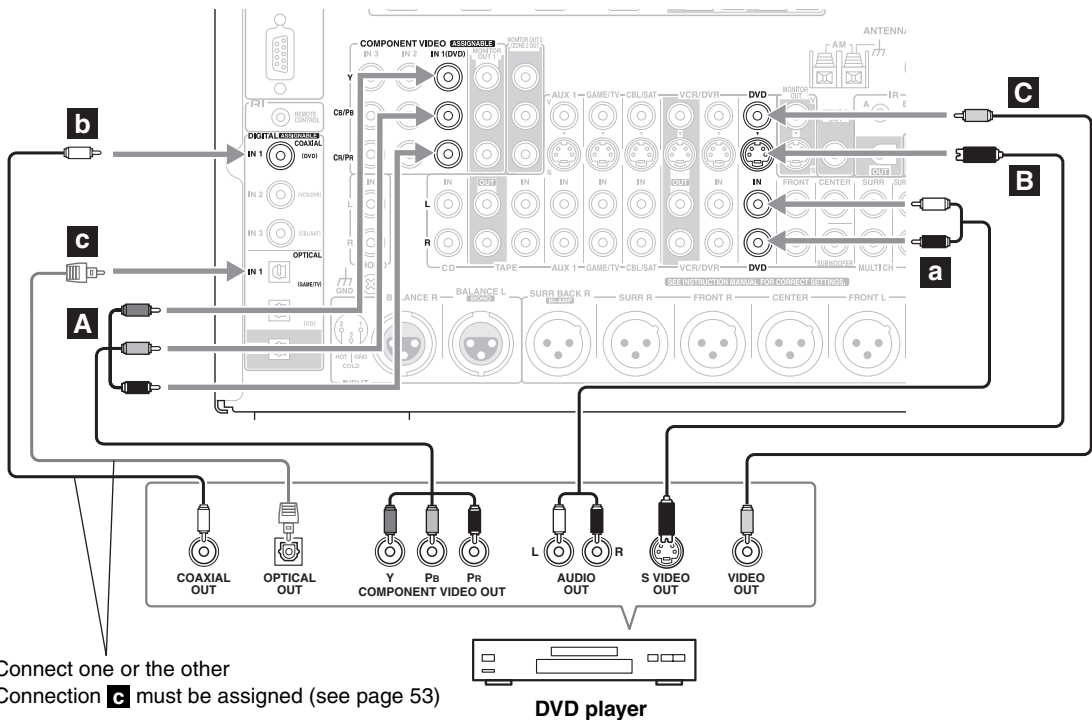

To connect a DVD player or DVD-Audio/SACD-capable player with a multichannel analog audio output, see page 33.

Connecting the AV Controller—Continued

Hooking Up the Multichannel Input

If your DVD player supports multichannel audio formats such as DVD-Audio and SACD, and it has a multichannel analog audio output, you can connect it to the AV controller's multichannel input.

Use a multichannel analog audio cable, or several normal audio cables, to connect the AV controller's MULTI CH: FRONT L/R, CENTER, SURR L/R, SURR BACK L/R, and SUBWOOFER jacks to the 7.1-channel analog audio output on your DVD player. If your DVD player has a 5.1-channel analog audio output, don't connect anything to the AV controller's SURR BACK L/R jacks.

Before using the multichannel input, you must assign it to an input selector. See "Analog Audio Input Setup" on page 54. To select the multichannel input, see "Selecting Audio Inputs" on page 129. To adjust the subwoofer sensitivity for the multichannel input, see "Subwoofer Input Sensitivity" on page 126.

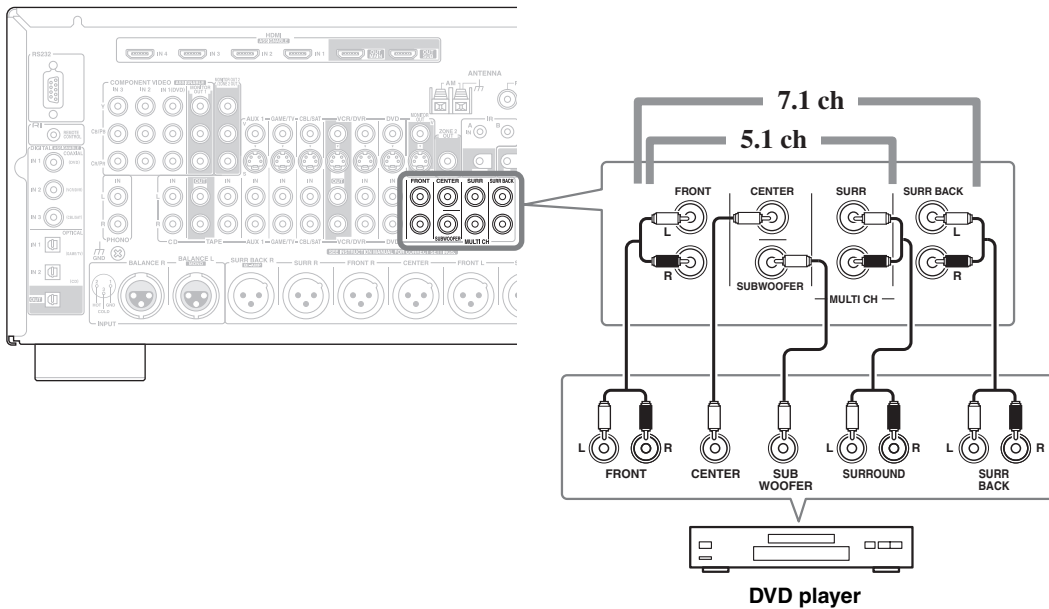

Connecting the AV Controller—Continued

Connecting a VCR or DVD Recorder for Playback



With this hookup, you can use the tuner in your VCR or DVR to listen to your favorite TV programs via the AV controller, which is useful if your TV has no audio outputs.

Step 1: Video Connection

Choose a video connection that matches your VCR or DVD recorder (**A**, **B**, or **C**), and then make the connection. If you use connection **A**, you must connect the AV controller to your TV with the same type of connection.

Step 2: Audio Connection

Choose an audio connection that matches your VCR or DVD recorder (**a**, **b**, or **c**), and then make the connection.

- With connection **a**, you can listen to the VCR or DVD recorder in Zone 2 or Zone 3.
- To enjoy Dolby Digital and DTS, use connection **b** or **c**. (To listen in Zone 2 or Zone 3 as well, use **a** and **b**, or **a** and **c**.)

Connection	AV controller	Signal flow	VCR or DVD recorder
A	COMPONENT VIDEO IN 2	←	Component video output
B	VCR/DVR IN S	←	S-Video output
C	VCR/DVR IN V	←	Composite video output
a	VCR/DVR IN L/R	←	Analog audio L/R output
b	DIGITAL COAXIAL IN 2 (VCR/DVR)	←	Digital coaxial output
c	DIGITAL OPTICAL IN 1 (GAME/TV)	←	Digital optical output

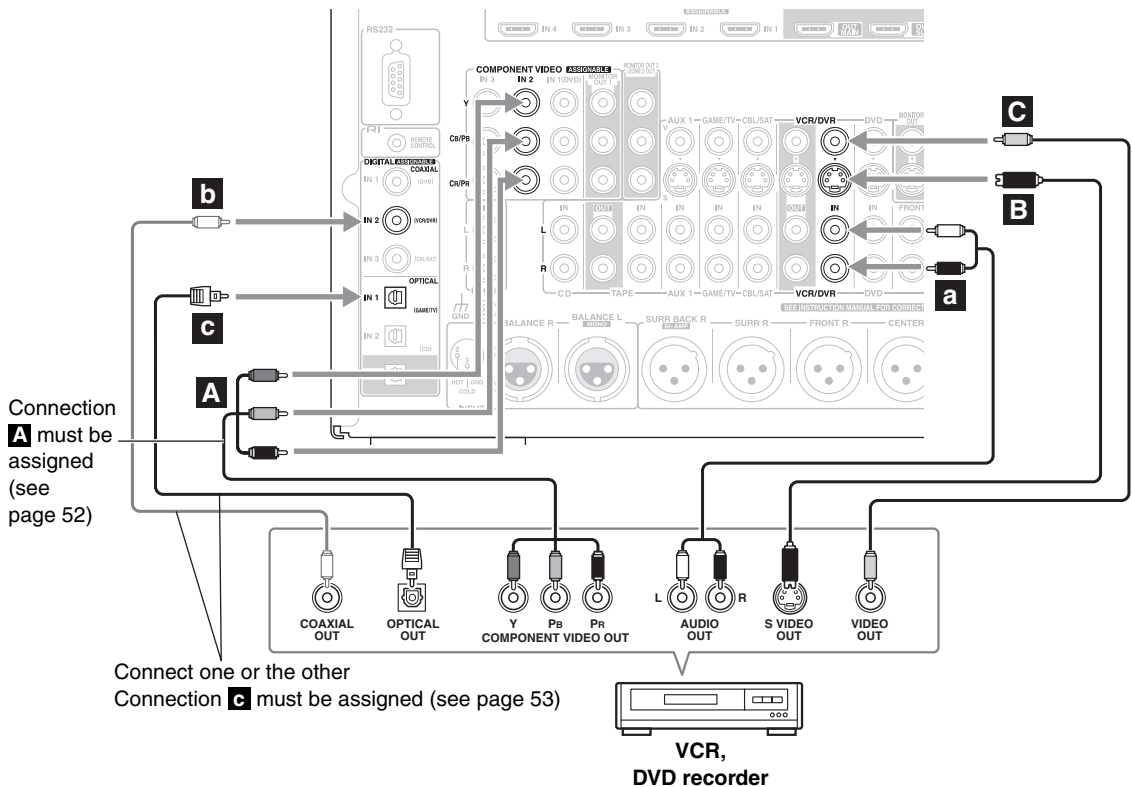

Connecting the AV Controller—Continued

Connecting a VCR or DVD Recorder for Recording

Step 1: Video Connection

Choose a video connection that matches your VCR or DVD recorder (**A** or **B**), and then make the connection. The video source to be recorded must be connected to the AV controller via the same type of connection.

Step 2: Audio Connection

Choose an audio connection that matches your VCR or DVD recorder (**a** or **b**), and then make the connection.

Connection	AV controller	Signal flow	VCR or DVD recorder
A	VCR/DVR OUT S	⇒	S-Video input
B	VCR/DVR OUT V	⇒	Composite video input
a	VCR/DVR OUT L/R	⇒	Audio L/R input
b	DIGITAL OPTICAL OUT	⇒	Digital optical input

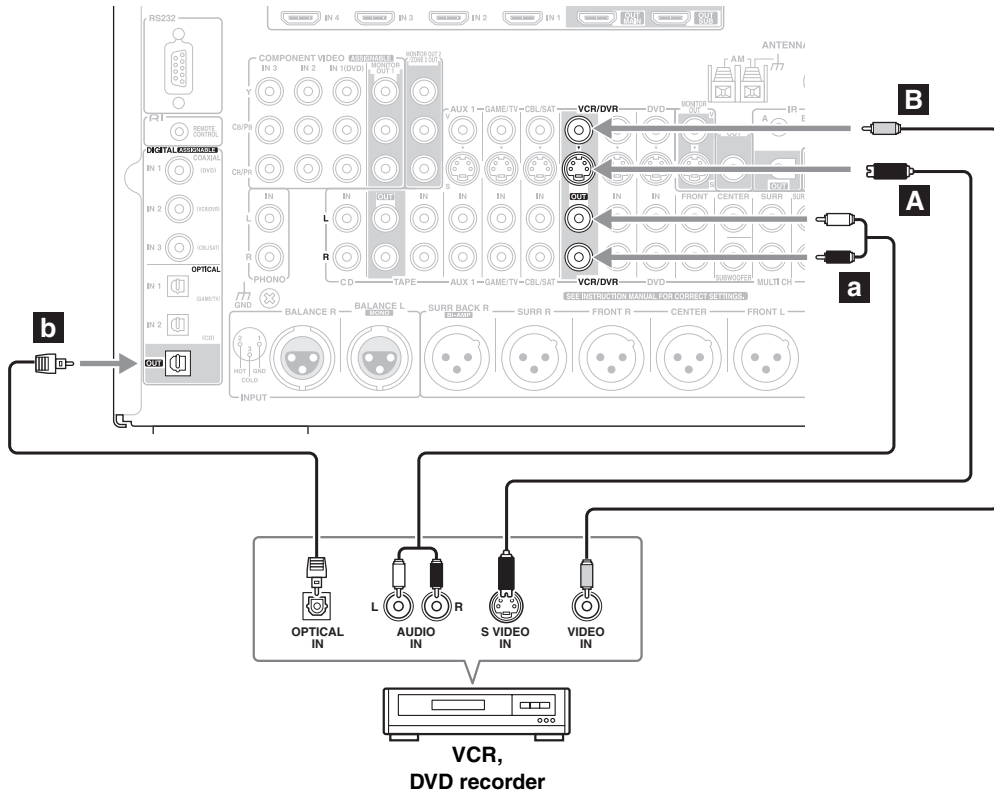

Notes:

- The AV controller must be turned on for recording. Recording is not possible while it's on Standby mode.
- If you want to record directly from your TV or another video source without going through the AV controller, connect the audio and video outputs from your TV or other video component directly to the recording VCR/DVD recorder's audio and video inputs. See the manuals supplied with your TV or VCR/DVD recorder for details.
- Video signals connected to composite video inputs can only be recorded via the VCR/DVR OUT V jack. So if your source TV or VCR is connected to a composite video input, the recording VCR/DVR must be connected to the VCR/DVR OUT V jack. Likewise, video signals connected to S-Video inputs can only be recorded via the VCR/DVR OUT S jack. So if your source TV or VCR is connected to an S-Video input, the recording VCR/DVD recorder must be connected to the VCR/DVR OUT S jack.

Connecting the AV Controller—Continued

Connecting a Satellite, Cable, Terrestrial Set-top box, or Other Video Source



With this hookup, you can use your satellite or cable receiver to listen to your favorite TV programs via the AV controller, which is useful if your TV has no audio outputs.

Step 1: Video Connection

Choose a video connection that matches the video source (**A**, **B**, or **C**), and then make the connection.

If you use connection **A**, you must connect the AV controller to your TV with the same type of connection.

Step 2: Audio Connection

Choose an audio connection that matches the video source (**a**, **b**, or **c**), and then make the connection.

- With connection **a**, you can listen to and record audio from the video source or listen in Zone 2 or Zone 3.
- To enjoy Dolby Digital and DTS, use connection **b** or **c**. (To record or listen in Zone 2 or Zone 3 as well, use **a** and **b**, or **a** and **c**.)

Connection	AV controller	Signal flow	Video source
A	COMPONENT VIDEO IN 3	←	Component video output
B	CBL/SAT IN S	←	S-Video output
C	CBL/SAT IN V	←	Composite video output
a	CBL/SAT IN L/R	←	Analog audio L/R output
b	DIGITAL COAXIAL IN 3 (CBL/SAT)	←	Digital coaxial output
c	DIGITAL OPTICAL IN 2 (CD)	←	Digital optical output

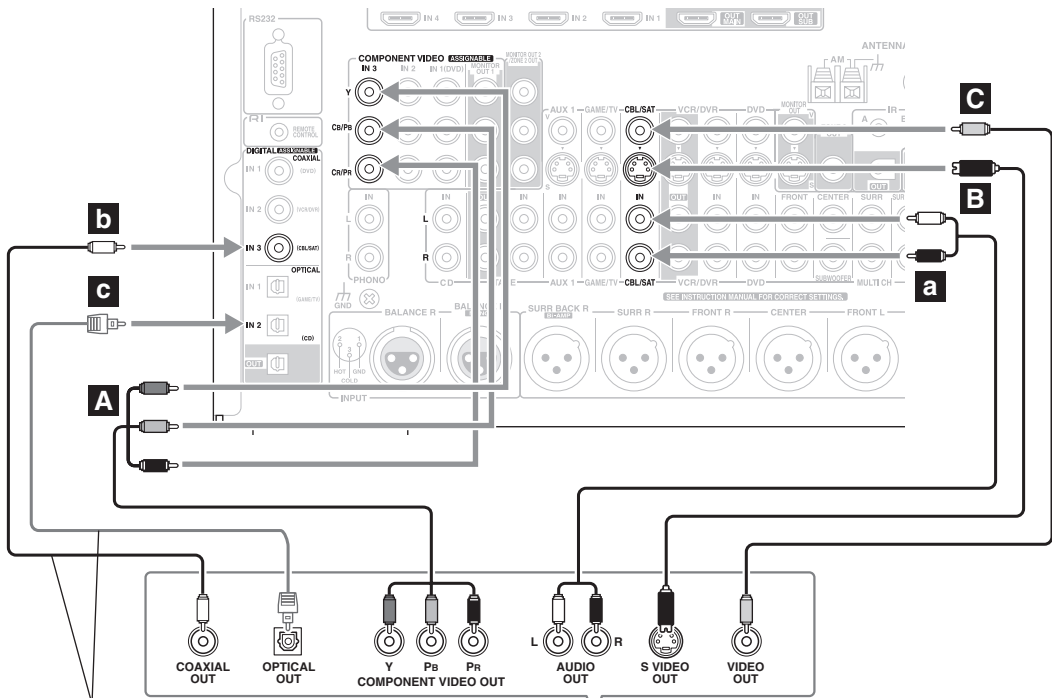

Connect one or the other
Connection **c** must be assigned (see page 53)

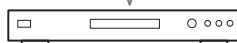

Satellite, cable, set-top box, etc.

Connecting Components with HDMI

About HDMI

Designed to meet the increased demands of digital TV, HDMI (High Definition Multimedia Interface) is a new digital interface standard for connecting TVs, projectors, DVD players, set-top boxes, and other video components. Until now, several separate video and audio cables have been required to connect AV components. With HDMI, a single cable can carry control signals, digital video, and up to eight channels of digital audio (2-channel PCM, multichannel digital audio, or multichannel PCM).

The HDMI video stream (i.e., video signal) is compatible with DVI (Digital Visual Interface)^{*1}, so TVs and displays with a DVI input can be connected by using an HDMI-to-DVI adapter cable. (This may not work with some TVs and displays, resulting in no picture.)

The AV controller uses HDCP (High-bandwidth Digital Content Protection)^{*2}, so only HDCP-compatible components will display a picture.

The AV controller's HDMI interface is based on the following standard:

Repeater System, Deep Color, Lip Sync, DTS-HD Master Audio, DTS-HD High Resolution Audio, Dolby TrueHD, Dolby Digital Plus, SA-CD, and Multichannel PCM

Supported Audio Formats

- 2-channel linear PCM (32–192 kHz, 16/20/24 bit)
- Multichannel linear PCM (7.1 ch, 32–192 kHz, 16/20/24 bit)
- Bitstream (DSD, Dolby Digital, Dolby Digital Plus, Dolby TrueHD, DTS, DTS-HD High Resolution, DTS-HD Master Audio)

Your DVD player must be able to output these formats from its HDMI OUT.

About Copyright Protection

The AV controller supports HDCP (High-bandwidth Digital Content Protection)^{*2}, a copy-protection system for digital video signals. Other devices connected to the AV controller via HDMI must also support HDCP.

Use a commercially available HDMI cable (supplied with some components) to connect the AV controller's HDMI OUT MAIN or HDMI OUT SUB to the HDMI input on your TV or projector.

*1 DVI (Digital Visual Interface): The digital display interface standard set by the DDWG^{*3} in 1999.

*2 HDCP (High-bandwidth Digital Content Protection): The video encryption technology developed by Intel for HDMI/DVI. It's designed to protect video content and requires a HDCP-compatible device to display the encrypted video.

*3 DDWG (Digital Display Working Group): Lead by Intel, Compaq, Fujitsu, Hewlett Packard, IBM, NEC, and Silicon Image, this open industry group's objective is to address the industry's requirements for a digital connectivity specification for high-performance PCs and digital displays.

Connecting the AV Controller—Continued

Making HDMI Connections

Step 1:

Use HDMI cables to connect the AV controller's HDMI jacks to your HDMI-compatible Blu-ray player/DVD player, TV, projector, and so on.

Step 2:

Assign each HDMI IN to an input selector. See "Video Input Setup" on page 50.

■ Video Signals

Digital video signals received by the HDMI IN jacks are normally output by the HDMI OUT MAIN and OUT SUB for display on your TV. Composite video, S-Video, and component video sources can be upconverted for the HDMI outputs. See "Video Connection Formats" on page 29 for more information.

■ Audio Signals

Digital audio signals received by the HDMI IN jacks are output by the speakers and headphones connected to the AV controller. Normally, they are not output by the HDMI outputs, unless the "Audio TV Out" setting is set to "On" (see page 126).



To listen to audio received by the HDMI IN jacks through your TV's speakers, set the "Audio TV Out" setting to "On" (see page 126), and set your DVD player's "Audio TV Output" setting to PCM.

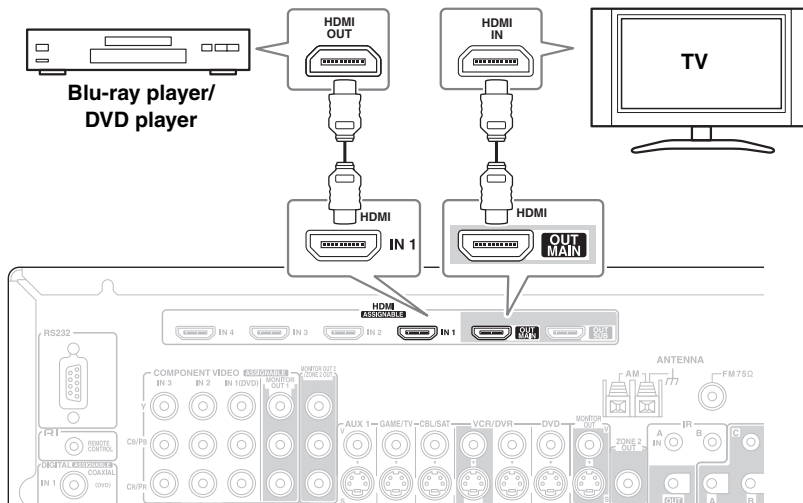

Notes:

- The HDMI video stream is compatible with DVI (Digital Visual Interface), so TVs and displays with a DVI input can be connected by using an HDMI-to-DVI adapter cable. (Note that DVI connections only carry video, so you'll need to make a separate connection for audio.) However, reliable operation with such an adapter is not guaranteed. In addition, video signals from a PC are not supported.
- When listening to an HDMI component through the AV controller, set the HDMI component so that its video can be seen on the TV screen (on the TV, select the input of the HDMI component connected to the AV controller). If the TV power is off or the TV is set to another input source, this may result in no sound from the AV controller or the sound may be cut off.
- When the "Audio TV Out" setting is set to "On" (see page 126), or "TV Control" is set to "Enable" (see page 127) and you're listening through your TV's speakers, if you turn up the AV controller volume control, the sound will be output by the AV controller's speakers. To stop the AV controller's speakers producing sound, change the settings, change your TV's settings, or turn down the AV controller's volume.
- The HDMI audio signal (sampling rate, bit length, etc.) may be restricted by the connected source component. If the picture is poor or there's no sound from a component connected via HDMI, check its setup. Refer to the connected component's instruction manual for details.

Connecting the AV Controller—Continued

Connecting a Game Console

Step 1: Video Connection

Choose a video connection that matches your game console (**A**, **B**, or **C**), and then make the connection.

If you use connection **A**, you must connect the AV controller to your TV with the same type of connection.

Step 2: Audio Connection

Choose an audio connection that matches your DVD player (**a**, **b**, or **c**), and then make the connection.

- With connection **a**, you can listen to and record audio from your game console or listen in Zone 2 or Zone 3.
- To enjoy Dolby Digital and DTS, use connection **b**. (To record or listen in Zone 2 or Zone 3 as well, use **a** and **b**.)

Connection	AV controller	Signal flow	Game console
A	COMPONENT VIDEO IN 3	←	Component video output
B	GAME/TV IN S	←	S-Video output
C	GAME/TV IN V	←	Composite video output
a	GAME/TV IN L/R	←	Analog audio L/R output
b	DIGITAL OPTICAL IN 1 (GAME/TV)	←	Digital coaxial output

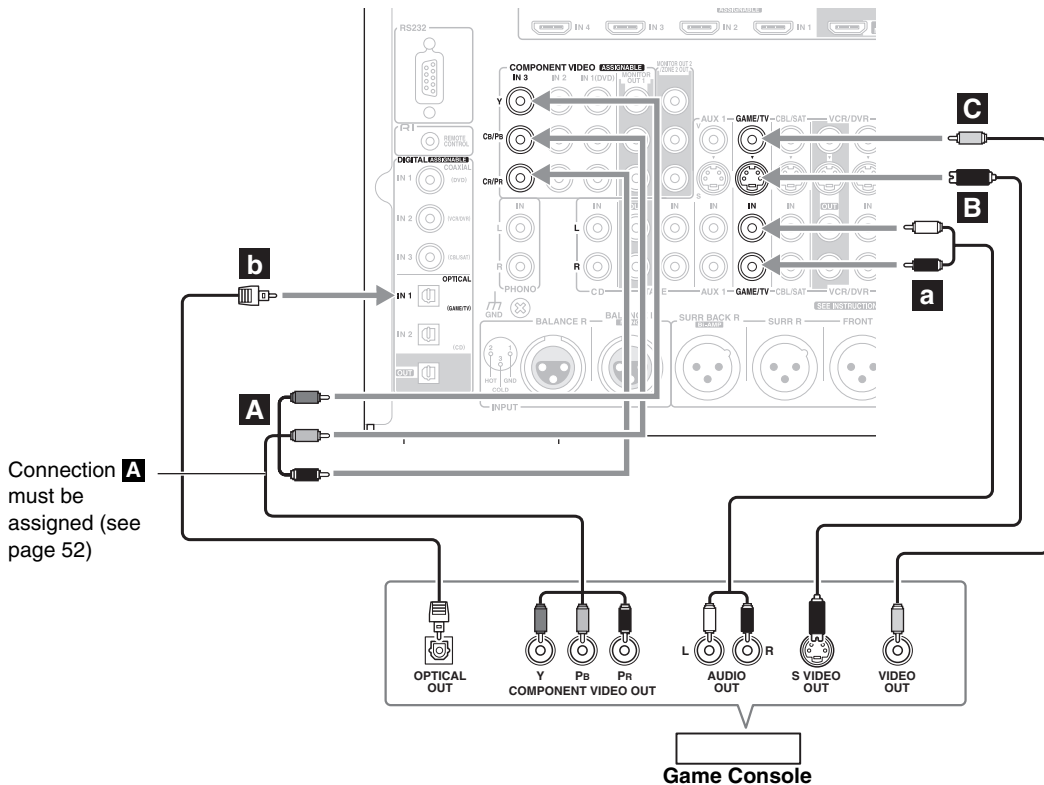

Connecting the AV Controller—Continued

Connecting a Camcorder or Other Device

Step 1: Video Connection

Choose a video connection that matches your camcorder (**A** or **B**), and then make the connection.

Step 2: Audio Connection

Choose an audio connection that matches your camcorder (**a** or **b**), and then make the connection.

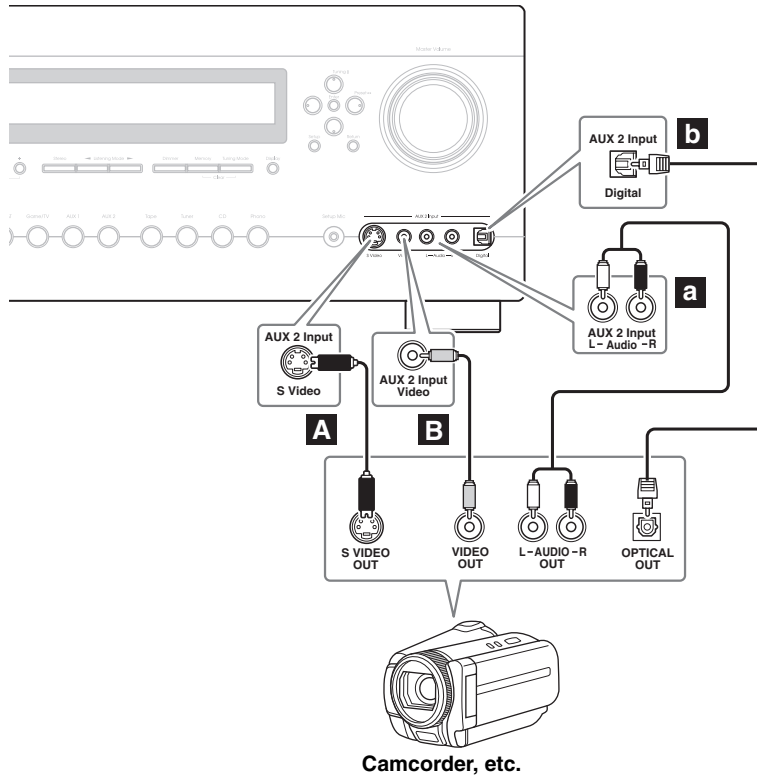

Connection	AV controller	Signal flow	Camcorder
A	AUX 2 Input S Video	←	S-Video output
B	AUX 2 Input Video	←	Composite video output
a	AUX 2 Input L-Audio-R	←	Analog audio L/R output
b	AUX 2 Input Digital	←	Digital optical output

Connecting a CD Player or Turntable

■ CD Player or Turntable (MM) with Built-in Phono Preamp

Step 1:

Choose a connection that matches your CD player (**a**, **b**, or **c**). Use connection **a** for a turntable with a built-in phono preamp.

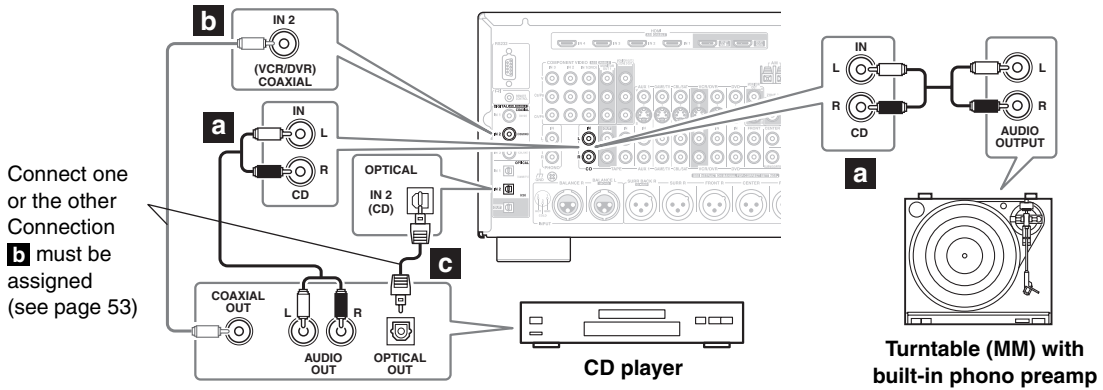

- With connection **a**, you can listen to and record audio from the CD player or listen in Zone 2 or Zone 3.
- To connect the CD player digitally, use connection **b** or **c**. (To record or listen in Zone 2 or Zone 3 as well, use **a** and **b**, or **a** and **c**.)

Connection	AV controller	Signal flow	CD or turntable
a	CD IN L/R	←	Analog audio L/R output
b	DIGITAL COAXIAL IN 2 (VCR/DVR)	←	Digital coaxial output
c	DIGITAL OPTICAL IN 2 (CD)	←	Digital optical output

■ Turntable (MM) with no Phono Preamp Built-in

The AV controller's PHONO IN is designed for use with a moving magnet (MM) type cartridge.

Use an analog audio cable to connect the AV controller's PHONO IN L/R jacks to the audio output on your turntable.

Notes:

- If your turntable has a ground wire, connect it to the AV controller's GND screw. With some turntables, connecting the ground wire may produce an audible hum. If this happens, disconnect it.
- If your turntable has a moving coil (MC) type cartridge, you'll need a commercially available MC head amp or MC transformer. Connect your turntable to the head amp or transformer, and connect that to the AV controller's PHONO IN L/R jacks.
- You can also use a phono equalizer to connect a turntable with an MC-type cartridge. See your phono equalizer's manual for details.

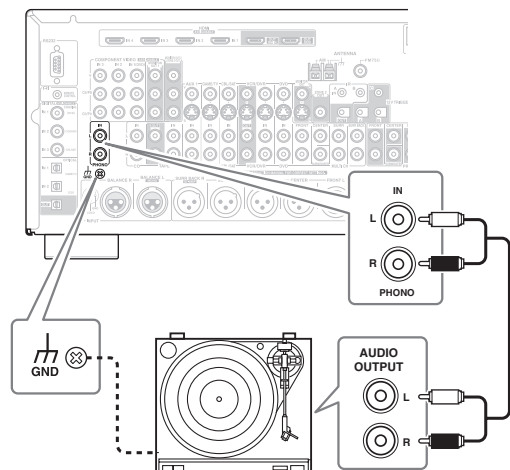

Connecting the AV Controller—Continued

Connecting a Cassette, CDR, MiniDisc, or DAT Recorder

Step 1:

Choose a connection that matches your recorder (**a**, **b**, **c**, or **d**), and then make the connection.

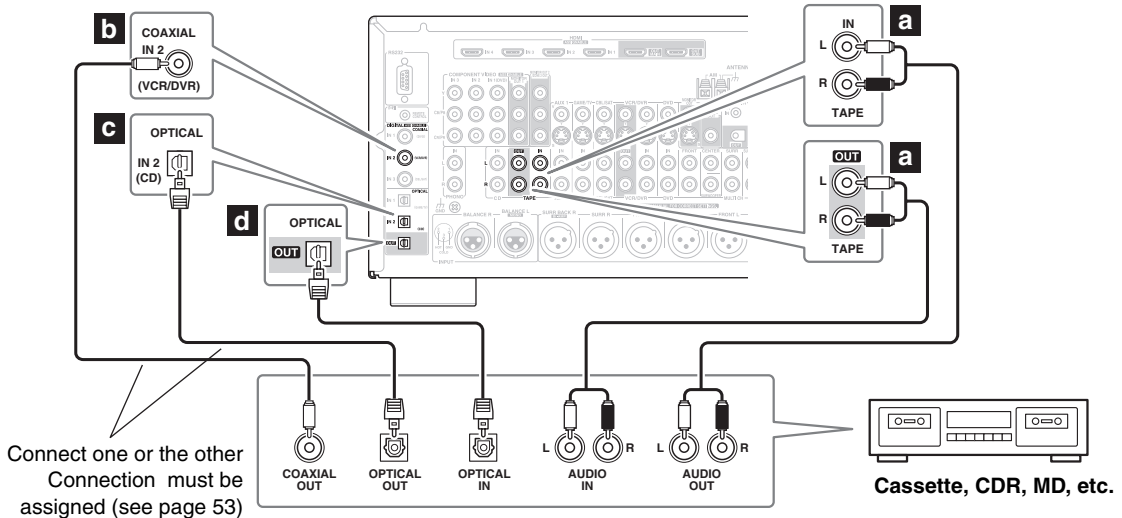

- With connection **a**, you can play and record or listen in Zone 2 or Zone 3.
- To connect the recorder digitally for playback, use connections **a** and **b**, or **a** and **c**.
- To connect the recorder digitally for recording, use connection **d**.

Connection	AV controller	Signal flow	Cassette, CDR, MD, or DAT recorder
a	TAPE IN L/R TAPE OUT L/R	← →	Analog audio L/R output Analog audio L/R input
b	DIGITAL COAXIAL IN 2 (VCR/DVR)	←	Digital coaxial output
c	DIGITAL OPTICAL IN 2 (CD)	←	Digital optical output
d	DIGITAL OPTICAL OUT	→	Digital optical input

Connecting a Balanced Audio Source

You can connect a balanced audio source to the AV controller's BALANCE L/R XLR jacks by using two XLR audio cables. To use the balanced input, you must assign it to an input selector (see page 54). If you connect a mono source, use the BALANCE L XLR jack and set the "Balance Input" setting to "Mono" (see page 54). The AV controller's balanced INPUT XLR jacks are wired as shown.

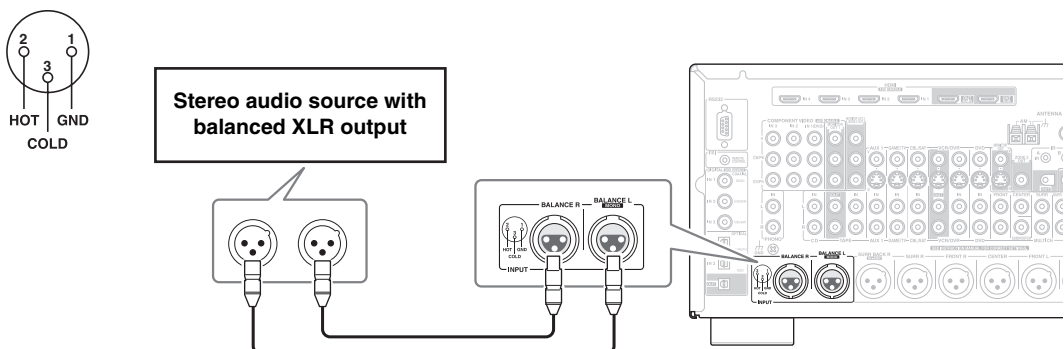

Connecting the AV Controller—Continued

Connecting an RI Dock

Not all iPod models output video. For information about which iPod models are supported by the RI Dock, see the RI Dock's instruction manual.

■ If Your iPod Supports Video:

Connect your RI Dock's audio output jacks to the AV controller's AUX 1 IN L/R jacks, and connect its video output jack to the AV controller's AUX 1 IN V jack.

(Onkyo DS-A2X hookup shown below.)

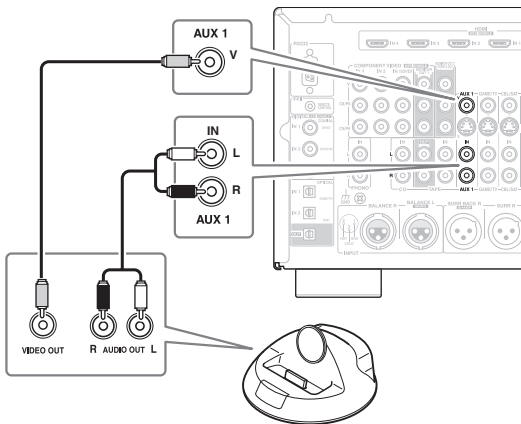

■ If Your iPod Doesn't Support Video:

Connect your RI Dock's audio output jacks to the AV controller's AUX 1 IN L/R jacks.

(Onkyo DS-A2X hookup shown below.)

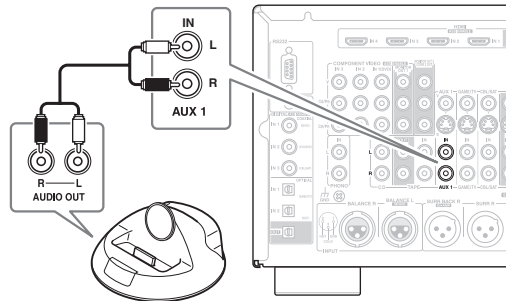

■ If you have an Onkyo DS-A1 RI Dock

- Connect its video output jack to the AV controller's AUX 1 jack.

Notes:

- Connect the RI Dock to the AV controller with an **RI** cable (see page 44).
- Set the RI Dock's RI MODE switch to "HDD" or "HDD/DOCK".
- Set the AV controller's Input Display to "DOCK" (see page 57).
- By using the [Dock] Remote Mode button on the remote controller of the AV controller to change the remote mode to "DOCK", you can operate your iPod in the RI Dock (see page 20).
If you cannot operate it, you will need to enter the appropriate remote control code (see page 137).
- See the RI Dock's instruction manual for more information.

Connecting the Power Cords of Other Components (North American model only)

The AV controller has AC outlet on its rear panel that can be used to connect the power cords of other components that you intend to use with the AV controller. These components can then be left turned on so that they turn on and off as and when the AV controller is set to On or Standby.

Caution:

- Make sure that the total capacity of the components that you connect to the AC OUTLET does not exceed the stated capacity.

Notes:

- When the "HDMI Control" setting is set to "Enable" (page 126), the AC outlet are on all the time regardless of whether the AV controller is set to On or Standby, or Ready mode in this case, so any components connected to them cannot be turned on or off automatically.
- Integra/Onkyo components connected via **RI** should be connected directly to a wall outlet, not an AC OUTLET on the AV controller.

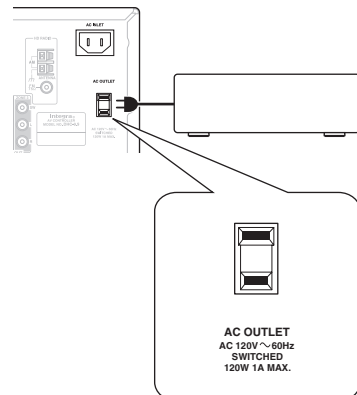

North American model

Connecting Integra/Onkyo **RI** Components

Step 1: Make sure that each Integra/Onkyo component is connected to the AV controller with an analog audio cable (RCA).

Step 2: Make the necessary **RI** connections (see illustration below).

Step 3: If you're using an MD, CDR, or RI DOCK component, change the Input Display (see page 57).

With **RI** (Remote Interactive), you can use the following special functions:

Auto Power On/Standby

When you start playback on a component connected via **RI**, if the AV controller is on Standby, it will automatically turn on and select that component as the input source. Similarly, when the AV controller is set to Standby, all components connected via **RI** will also go on Standby. This function will not work with components that are connected to an AC OUTLET on the AV controller.

Direct Change

When playback is started on a component connected via **RI**, the AV controller automatically selects that component as the input source. If your DVD player is connected to the AV controller's multichannel input, you'll need to press the [Audio Sel] button repeatedly and select Multich to hear all channels (see page 129), as the Direct Change **RI** function selects the DVD IN L/R jacks.

Remote Control

You can use the AV controller's remote controller to control your other **RI**-capable Integra/Onkyo components. You must enter the appropriate remote control code first (see page 138). And remember to point the remote controller at the AV controller and not the other component.

Notes:

- Use only **RI** cables for **RI** connections. **RI** cables are supplied with Integra/Onkyo players (DVD, CD, etc.).
- Some components have two **RI** jacks. You can connect either one to the AV controller. The other jack is for connecting additional **RI**-capable components.
- Connect only Integra/Onkyo components to **RI** jacks. Connecting other manufacturer's components may cause a malfunction.
- Some components may not support all **RI** functions. Refer to the manuals supplied with your other Integra/Onkyo components.
- While Zone 2 or Zone 3 is on, the Auto Power On/Standby and Direct Change **RI** functions do not work.

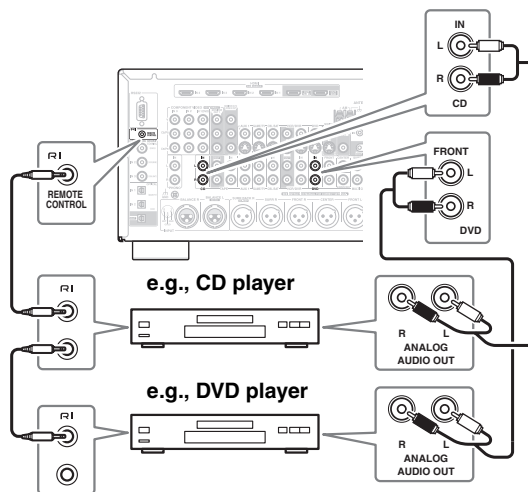

Connecting the Power Cord

- **Before connecting the power cord, connect all your speakers and AV components.**
- Connect the power cord to the AV controller's AC INLET.
- Plug the other end of the power cord into a suitable wall outlet.
- Turning on the AV controller may cause a momentary power surge that might interfere with other electrical equipment on the same circuit. If this is a problem, plug the AV controller into a different branch circuit.

Turning On the AV Controller

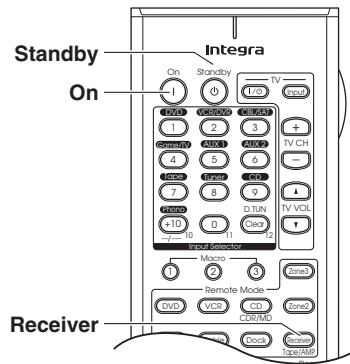
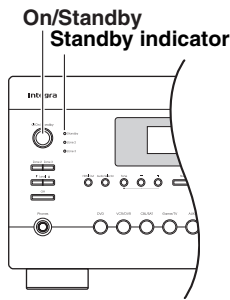

Turning On and Standby

AV controller



or

Remote controller



On the AV controller, press the [On/Standby] button.

On the remote controller, press the [Receiver] Remote Mode button, followed by the [On] button.

The AV controller comes on, the display lights up, and the Standby indicator goes off.

Pressing the remote controller's [On] button again will turn on any components connected via **RI**.

To turn the AV controller off, press the [On/Standby] button, or press the remote controller's [Standby] button. The AV controller will enter Standby mode. To prevent any loud surprises the next time you turn on the AV controller, turn down the volume before you turn it off.

Up and Running in a Few Easy Steps

To get your system up and running with the minimum of fuss, here's a few pointers to help you configure the AV controller before you use it for the very first time. These settings only need to be made once.

■ Do the automatic speaker setup—this is essential!

See "Automatic Speaker Setup (Audyssey MultEQ[®] XT)" on page 58.



■ Did you connect your TV to an HDMI OUT or COMPONENT VIDEO MONITOR OUT 1 or 2?

If you did, see "Monitor Out Setup" on page 49.



■ Did you connect a component to an HDMI input, component video input, or digital audio input?

If you did, see "Video Input Setup" on page 50, "Component Video Setup" on page 52, or "Digital Audio Input Setup" on page 53 respectively.

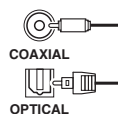
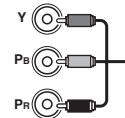

■ Did you connect an Integra/Onkyo MD recorder, CD recorder, or RI Dock?

If you did, see "Changing the Input Display" on page 57.



MD recorder, CD recorder, RI Dock

First Time Setup

This section explains the settings that you need to make before using the AV controller for the very first time.

Monitor Setup

On the “Monitor Out” settings, you can select whether or not to have the video sources’ images output through the HDMI Out, as well as whether to have the onscreen setup menu output through the HDMI Out or through an analog output.

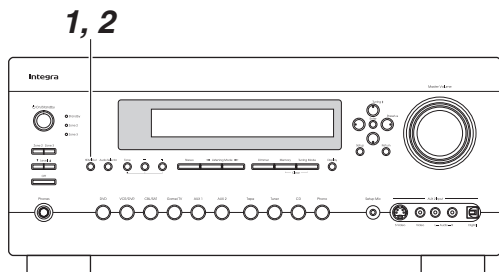

If you connect your TV to the COMPONENT VIDEO MONITOR OUT, set the “Monitor Out” setting to “Analog” so that the onscreen setup menus are displayed and composite video and S-Video sources are upconverted* and output by the COMPONENT VIDEO MONITOR OUT 1 or 2.

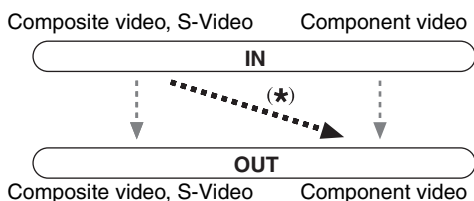

If you connect your TV to the HDMI OUT MAIN or HDMI OUT SUB, set the “Monitor Out” setting to “HDMI Main” or “HDMI Sub” so that the onscreen setup menus are displayed and composite video, S-Video, and component video sources are upconverted* and output by the HDMI OUT MAIN or HDMI OUT SUB. The onscreen setup menus are displayed on the HDMI OUT MAIN or HDMI OUT SUB only.

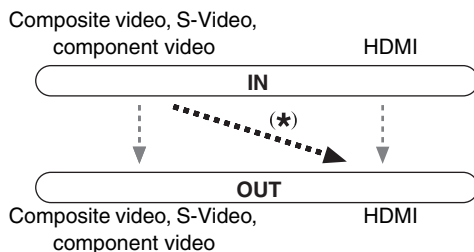

You can specify the output resolution for the HDMI OUT MAIN or HDMI OUT SUB and COMPONENT VIDEO MONITOR OUT and have the AV controller upconvert the picture resolution as necessary to match the resolution supported by your TV (see page 119).

1

HDMI Out

Press the [HDMI Out] button.
The current setting is displayed.

Monitor Out
#HDMI Main

2

HDMI Out

Press the [HDMI Out] button repeatedly to select:

Analog:
Select this if your TV is connected to a video output other than the HDMI OUT MAIN or HDMI OUT SUB.

HDMI Main:
Select this if your TV is connected to the HDMI OUT MAIN.

HDMI Sub:
Select this if your TV is connected to the HDMI OUT SUB.

Note:
When “HDMI Main” or “HDMI Sub” is selected, the onscreen setup menus are output by only the HDMI outputs.
If you’re not using the HDMI outputs and select “HDMI Main” or “HDMI Sub” by mistake and the menus disappear, press the [HDMI Out] button to select “Analog”.

Note:
See page 29 for charts showing how the “Monitor Out” and “Resolution” (see pages 49, 50) settings affect the video signal flow through the AV controller.

First Time Setup—Continued

In this Instruction Manual, illustrations from the onscreen menu or explanations referring to the menu will be in the same language as the Instruction Manual. The default Language setting for the onscreen menu is English. If your Instruction Manual is in a language other than English, first follow the instructions below to change the Language.

Selecting the Language used for the onscreen setup menus

This setting determines the language used for the onscreen setup menus. You can select: English, German, French, Spanish, Italian, Dutch, Swedish, or Japanese.

1



Press the [Receiver] button, followed by the [Setup] button.

The main menu appears onscreen.

If the main menu doesn't appear, make sure the appropriate external input is selected on your TV.

2

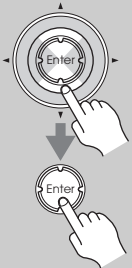

Use the Up and Down [▲]/[▼] buttons to select “6. Miscellaneous”, and then press [Enter].

The “Miscellaneous” menu appears.

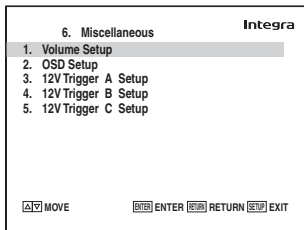

3

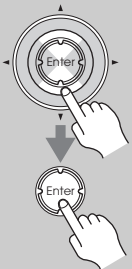

Use the Up and Down [▲]/[▼] buttons to select “2. OSD Setup”, and then press [Enter].

The “OSD Setup” menu appears.

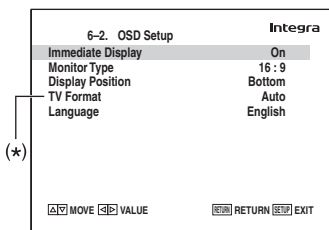

Note:

The “TV Format” (*) setting is not available on the North American models.

4

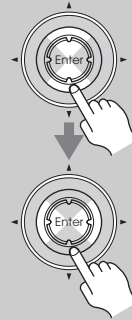

Use the Up and Down [▲]/[▼] buttons to select “Language”, and then use the Left and Right [◀]/[▶] buttons to select: English, German, French, Spanish, Italian, Dutch, Swedish, Japanese

5



Press the [Setup] button. The setup menu closes.

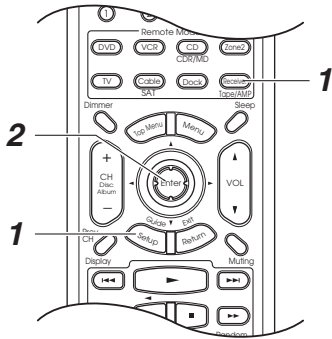

Menus for First Time Setup

Using the Onscreen Setup Menus

Carry out the settings for the AV controller by using the Onscreen Setup Menu.

1



Press the [Receiver] button followed by the [Setup] button.

The main menu appears onscreen.

If the main menu doesn't appear, make sure the appropriate external input is selected on your TV.

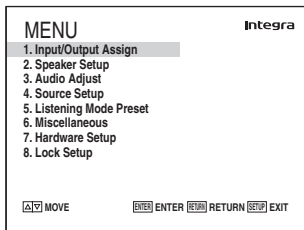

2

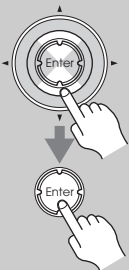

Use the Up and Down [▲]/[▼] buttons to select submenu and then press [Enter].

The submenu appears.

Press the [Setup] button to close the menu.

Press the [Return] button to return to the previous menu.

Submenus

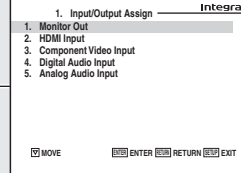

p. 49

p. 54

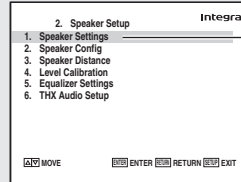

p. 55

Main menu

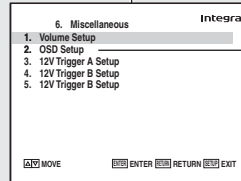
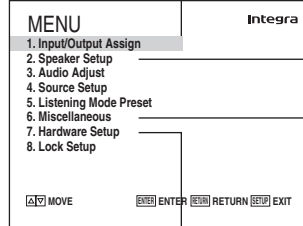

p. 56

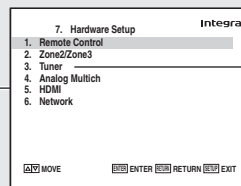

p. 57

Monitor Out Setup

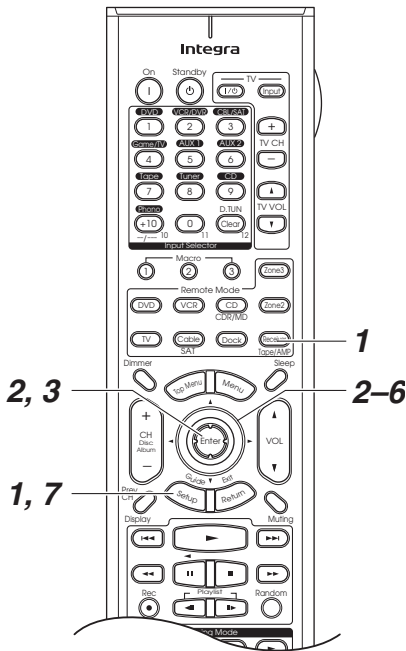

If you connect your TV to the COMPONENT VIDEO MONITOR OUT, set the “Monitor Out” setting to “Analog” so that the onscreen setup menus are displayed and composite video and S-Video sources are upconverted and output by the COMPONENT VIDEO MONITOR OUT 1 or 2.

If you connect your TV to the HDMI OUT MAIN or HDMI OUT SUB, set the “Monitor Out” setting to “HDMI Main” or “HDMI Sub”, respectively, so that the onscreen setup menus are displayed and composite video, S-Video, and component video sources are upconverted and output by the HDMI OUT MAIN or HDMI OUT SUB.

You can specify the output resolution for the HDMI outputs and COMPONENT VIDEO MONITOR OUT and have the AV controller upconvert the picture resolution as necessary to match the resolution supported by your TV.

1

Press the [Receiver] button, followed by the [Setup] button.

The main menu appears onscreen.

If the main menu doesn't appear, make sure the appropriate external input is selected on your TV.



2

Use the Up and Down [▲]/[▼] buttons to select “1. Input/Output Assign”, and then press [Enter].

The “Input/Output Assign” menu appears.

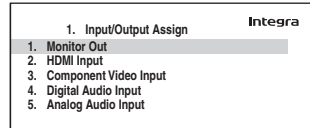
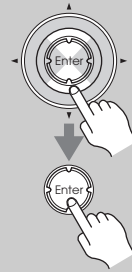

3

Use the Up and Down [▲]/[▼] buttons to select “1. Monitor Out”, and then press [Enter].

The “Monitor Out” menu appears.

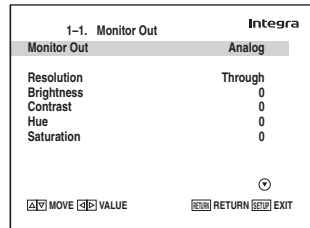
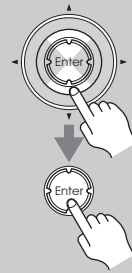

4

Use the Up and Down [▲]/[▼] buttons to select “Monitor Out”, and use the Left and Right [◀]/[▶] buttons to select:

Analog:

Select this if your TV is connected to a video output other than the HDMI OUT MAIN or HDMI OUT SUB.

HDMI Main:

Select this if your TV is connected to the HDMI OUT MAIN.

HDMI Sub:

Select this if your TV is connected to the HDMI OUT SUB.

Note:

When “HDMI Main” or “HDMI Sub” is selected, the onscreen setup menus are output by only the HDMI outputs. If you're not using the HDMI outputs and select “HDMI Main” or “HDMI Sub” by mistake and the menus disappear, press the AV controller's [HDMI Out] button so that “Monitor Out: Analog” appears on the display.



5



Use the Up and Down [▲]/[▼] buttons to select “Resolution”, and use the Left and Right [◀]/[▶] buttons to select:

Through:

Select this to pass video through the AV controller at the same resolution and with no conversion.

Auto:

Select this to have the AV controller automatically convert video at resolutions not supported by your TV. (Not available when the “Monitor Out” setting is set to “Analog.”)

480p:

Select this for 480p output and video conversion as necessary.

720p:

Select this for 720p output and video conversion as necessary.

1080i:

Select this for 1080i output and video conversion as necessary.

1080p:

Select this for 1080p output and video conversion as necessary. (Not available when the “Monitor Out” setting is set to “Analog.”)

Source:

Output will be according to the resolution level which was set with Resolution inside Source: 4-4. Picture Adjust. (Setting for each Source becomes possible.)

6

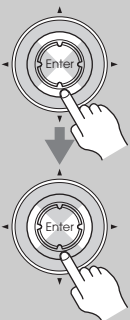

Use the Up and Down [▲]/[▼] buttons to select “Component Out2”, and use the Left and Right [◀]/[▶] buttons to select:

Monitor:

Select this if you’ve connected the COMPONENT VIDEO MONITOR OUT 2/ZONE 2 OUT to a TV or other component in your main room.

Zone 2:

Select this if you’ve connected the COMPONENT VIDEO MONITOR OUT 2/ZONE 2 OUT to a TV in Zone 2.

When Monitor is selected, the COMPONENT VIDEO MONITOR OUT 2/ZONE 2 OUT outputs the same video as the COMPONENT VIDEO MONITOR OUT 1.

7



Press the [Setup] button.

Setup closes.

Notes:

- If the video source contains information that restricts output at high-resolutions, 720p or 1080i content will not be converted.
- See page 30 for charts showing how the “Monitor Out” and “Resolution” settings affect the video signal flow through the AV controller.
- This procedure can also be performed on the AV controller by using its [Setup] button, arrow buttons, and [Enter] button.

Video Input Setup

HDMI Input Setup

If you connect a video component to an HDMI IN, you must assign that input to an input selector. For example, if you connect your DVD player to HDMI IN 1, you must assign HDMI IN 1 to the DVD input selector.

By default, none of the HDMI inputs are assigned.

If you’ve connected your TV to the AV controller with an HDMI cable, you can set the AV controller so that composite video, S-Video, and component video sources are upconverted and output by the HDMI outputs. You can set this for each input selector by selecting the “- - -” option.

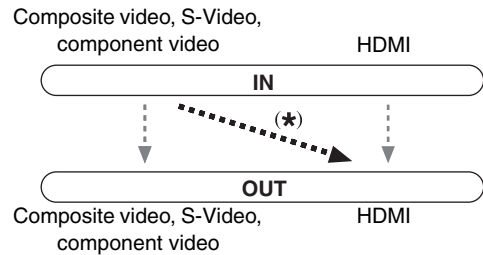

1

Press the [Receiver] button, followed by the [Setup] button.

The main menu appears onscreen. If the main menu doesn’t appear, make sure the appropriate external input is selected on your TV.



2

Use the Up and Down [▲]/[▼] buttons to select “1. Input/Output Assign”, and then press [Enter].

The “Input/Output Assign” menu appears.

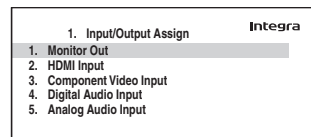

3

Use the Up and Down [▲]/[▼] buttons to select “2. HDMI Input”, and then press [Enter].

The “HDMI Input” menu appears.

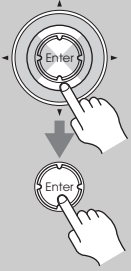

1-2. HDMI Input		Integra
DVD	---	
VCR/DVR	---	
CBL/SAT	---	
GAME/TV	---	
AUX1	---	
AUX2	---	

MOVE VALUE RETURN EXIT

1-2. HDMI Input		Integra
TAPE	---	⊙
TUNER	---	
CD	---	
PHONO	---	

MOVE VALUE RETURN EXIT

page 49), and the “HDMI Input” setting must be set to “- - -”. See page 29 for more information on video signal flow and upconversion.

- When an HDMI IN is assigned to an input selector as explained here, the digital audio input for that input selector is automatically set to the same HDMI IN. See “Digital Audio Input Setup” on page 53.
- The “TUNER” input selector cannot be assigned and is fixed at the “- - -” option.
- This procedure can also be performed on the AV controller by using its [Setup] button, arrow buttons, and [Enter] button.

4

Use the Up and Down [▲]/[▼] buttons to select an input selector, and use the Left and Right [◀]/[▶] buttons to select:

HDMI1, HDMI2, HDMI3, HDMI4:

Select the HDMI IN to which the video component has been connected.

---:

Output composite video, S-Video, and component video sources from the HDMI Out. The video output signal from the HDMI Out is the one configured in “Component Video Setup” (see page 52).

Each HDMI IN cannot be assigned to more than one input selector. When HDMI1 - HDMI4 have already been assigned, you must set first any unused input selectors to “- - -” or you will be unable to assign HDMI1 - HDMI4 to input selector.



5

Press the [Setup] button.

Setup closes.



Notes:

- For composite video, S-Video, and component video upconversion for the HDMI OUT MAIN or HDMI OUT SUB, the “Monitor Out” setting must be set to “HDMI Main” or “HDMI Sub”, respectively (see

Component Video Setup

If you connect a video component to a COMPONENT VIDEO IN, you must assign that input to an input selector. For example, if you connect your DVD player to COMPONENT VIDEO IN 3, you must assign COMPONENT VIDEO IN 3 to the DVD input selector.

By default, the DVD input selector is assigned to COMPONENT VIDEO IN 1, and all of the other input selectors are assigned to the “- -” option.

Input selector	Default assignment
DVD	IN1
VCR/DVR	- - -
CBL/SAT	- - -
GAME/TV	- - -
AUX1	- - -
AUX2	- - -
TAPE	- - -
TUNER	- - - (Fixed)
CD	- - -
PHONO	- - -

If you’ve connected your TV to the AV controller with a component video cable, you can set the AV controller so that composite video and S-Video sources are upconverted* and output by the COMPONENT VIDEO MONITOR OUT 1 or 2. You can set this for each input selector by selecting the “- -” option.

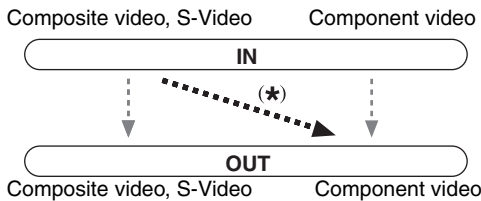

1



Press the [Receiver] button, followed by the [Setup] button.

The main menu appears onscreen. If the main menu doesn’t appear, make sure the appropriate external input is selected on your TV.

2



Use the Up and Down [▲]/[▼] buttons to select “1. Input/Output Assign”, and then press [Enter].

The “Input/Output Assign” menu appears.

1. Input/Output Assign		Integra
1. Monitor Out		
2. HDMI Input		
3. Component Video Input		
4. Digital Audio Input		
5. Analog Audio Input		

3



Use the Up and Down [▲]/[▼] buttons to select “3. Component Video Input”, and then press [Enter].

The “Component Video Input” menu appears.

1-3. Component Video Input		Integra
DVD		IN1
VCR/DVR		- - -
CBL/SAT		- - -
GAME/TV		- - -
AUX1		- - -
AUX2		- - -

1-3. Component Video Input		Integra
TAPE		- - -
TUNER		- - -
CD		- - -
PHONO		- - -

4



Use the Up and Down [▲]/[▼] buttons to select an input selector, and use the Left and Right [◀]/[▶] buttons to select:

- IN1:** Use the video component connected to COMPONENT VIDEO IN 1.
- IN2:** Use the video component connected to COMPONENT VIDEO IN 2.
- IN3:** Use the video component connected to COMPONENT VIDEO IN 3.
- - -:** Output composite video and S-Video sources from the COMPONENT VIDEO MONITOR OUT.

5



Press the [Setup] button. Setup closes.

Notes:

- For composite video and S-Video upconversion for the COMPONENT VIDEO MONITOR OUT 1 or 2, the “Monitor Out” setting must be set to “Analog” (see page 49), and the “Component Video Input” setting must be set to “- - -”. See page 30 for more information on video signal flow and upconversion.
- This procedure can also be performed on the AV controller by using its [Setup] button, arrow buttons, and [Enter] button.

Digital Audio Input Setup

If you connect a component to a digital audio input, you must assign that input to an input selector. For example, if you connect your CD player to OPTICAL IN 2, you must assign OPTICAL IN 2 to the “CD” input selector. Here are the default assignments.

Input selector	Default assignment
DVD	COAX1
VCR/DVR	COAX2
CBL/SAT	COAX3
GAME/TV	OPT1
AUX1	- - -
AUX2	FRONT (Fixed)
TAPE	- - -
TUNER	- - - (Fixed)
CD	OPT2
PHONO	- - -

1 Press the [Receiver] button, followed by the [Setup] button.



The main menu appears onscreen. If the main menu doesn't appear, make sure the appropriate external input is selected on your TV.

2 Use the Up and Down [▲]/[▼] buttons to select “1. Input/Output Assign”, and then press [Enter].

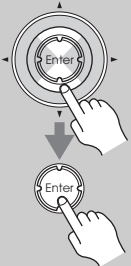

The “Input/Output Assign” menu appears.

1. Input/Output Assign		Integra
1. Monitor Out		
2. HDMI Input		
3. Component Video Input		
4. Digital Audio Input		
5. Analog Audio Input		

3 Use the Up and Down [▲]/[▼] buttons to select “4. Digital Audio Input”, and then press [Enter].

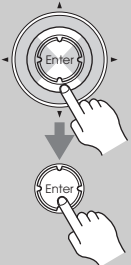

The “Digital Audio Input” menu appears.

1-4. Digital Audio Input		Integra
DVD	COAX1	
VCR/DVR	COAX2	
CBL/SAT	COAX3	
GAME/TV	OPT1	
AUX	- - -	
AUX2	FRONT	
TAPE	- - -	
TUNER	- - -	
CD	OPT2	
PHONO	- - -	

▲ MOVE [Enter] VALUE [Enter] RETURN [Enter] EXIT

4

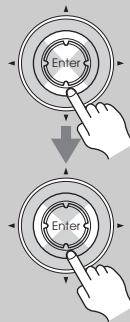

Use the Up and Down [▲]/[▼] buttons to select an input selector, and then use the Left and Right [◀]/[▶] buttons to select: “COAX1”, “COAX2”, “COAX3”, “OPT1”, “OPT2”, or “- - - (analog)”.

- When an HDMI IN is assigned to an input selector in “HDMI Input Setup” on page 50, this input assignment is automatically set to the same HDMI IN. And in addition to the usual inputs (e.g., COAX1, COAX2, etc.), you can also select HDMI inputs.
- “AUX2” is used only for digital input from the front panel terminals. When HDMI IN is assigned to “AUX2” in the “HDMI Input Setup” on page 50, the same HDMI IN can be selected.

Examples:

If you connect your DVD player to the OPTICAL IN 1 jack, set “DVD” to “OPT1”.

If you want to listen to audio from the component connected to the OPTICAL IN 2 jack when the VCR/DVR input selector is selected, set “VCR/DVR” to “OPT2”.

If you want to listen to audio from the component connected to the COAXIAL IN 1 jack when the CBL/SAT input selector is selected, set “CBL/SAT” to “COAX1”.

For input selectors that you don't want to assign a digital input jack, set to “- - - (analog)”.

5



Press the [Setup] button. Setup closes.

Notes:

- Only FRONT can be assigned to the AUX 2 input selector.
- This procedure can also be performed on the AV controller by using its [Setup] button, arrow buttons, and [Enter] button.

Analog Audio Input Setup

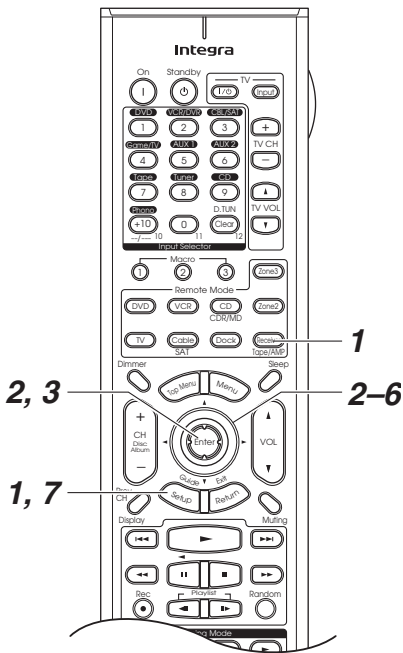

If you connect a component to the AV controller’s analog multichannel input, you must assign that input to an input selector. For example, if you connect your DVD player to the MULTI CH input, you must assign it to the DVD input selector.

If you connect a component to the AV controller’s balanced input, you must assign that input to an input selector. For example, if you connect your CD player to the BALANCED input, you must assign it to the CD input selector.

1 Press the [Receiver] button, followed by the [Setup] button. The main menu appears onscreen. If the main menu doesn’t appear, make sure the appropriate external input is selected on your TV.



2 Use the Up and Down [▲]/[▼] buttons to select “1. Input/Output Assign”, and then press [Enter]. The “Input/Output Assign” menu appears.



Integra	
1.	Input/Output Assign
2.	Monitor Out
3.	HDMI Input
4.	Component Video Input
5.	Digital Audio Input
5.	Analog Audio Input

3 Use the Up and Down [▲]/[▼] buttons to select “5. Analog Audio Input”, and then press [Enter]. The “Analog Audio Input” menu appears.



Integra	
1-5. Analog Audio Input	
Multich	DVD
Balance	CD
Balance Input	Stereo

4 Use the Left and Right [◀]/[▶] buttons to select an input selector. You can assign the multichannel input to the following input selectors: “DVD”, “VCR/DVR”, “CBL/SAT”, “GAME/TV”, “AUX1”, “AUX2”, “TAPE”, “CD”, or “PHONO”.



5 Use the Up and Down [▲]/[▼] buttons to select “Balance”, and use the Left and Right [◀]/[▶] buttons to select an input selector: You can assign the balanced input to the following input selectors: DVD, “DVD”, “VCR/DVR”, “CBL/SAT”, “GAME/TV”, “AUX1”, “AUX2”, “TAPE”, “CD”, or “PHONO”.



6 Use the Up and Down [▲]/[▼] buttons to select “Balance Input”, and use the Left and Right [◀]/[▶] buttons to select: **Stereo:** Select if the source is stereo and you’ve connected it to the BALANCED L and R INPUT XLR jacks. **Mono:** Select if the source is mono and you’ve connected it to the BALANCED L INPUT XLR jack.



7 Press the [Setup] button. Setup closes.



Notes:

- To listen to the component connected to the multichannel input, press the [Audio Sel] button repeatedly to select Multich (see page 129).
- This procedure can also be performed on the AV controller by using its [Setup] button, arrow buttons, and [Enter] button.

Speaker Settings

If you change these settings, you must run the automatic speaker setup again (see page 58).

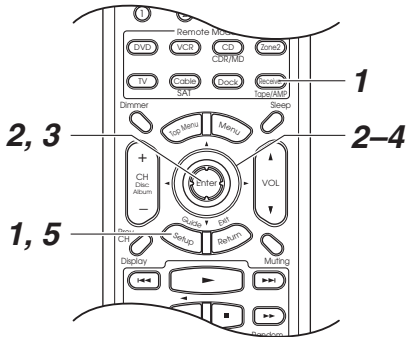

To use bi-amping, you must change the “Speaker Type” setting. For hookup information, see page 25.

Notes:

- When bi-amping is used, the AV controller is able to drive up to 5.1 speakers in the main room.
- Before you change these settings, turn down the volume.

The onscreen menus shown in this manual may be slightly different from what you see on your TV.

1



Press the [Receiver] button, followed by the [Setup] button.

The main menu appears onscreen.

If the main menu doesn't appear, make sure the appropriate external input is selected on your TV.

2

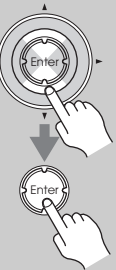

Use the Up and Down [▲]/[▼] buttons to select “2. Speaker Setup”, and then press [Enter].

The “Speaker Setup” menu appears.

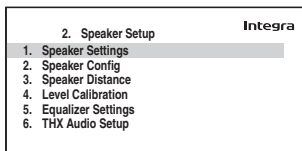

3

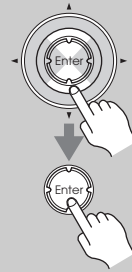

Use the Up and Down [▲]/[▼] buttons to select “1. Speaker Settings”, and then press [Enter].

The “Speaker Settings” menu appears.

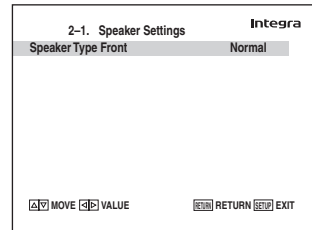

4



Use the Up and Down [▲]/[▼] buttons to select “Speaker Type”, and use the Left and Right [◀]/[▶] buttons to select:

Normal:

Select this if you've connected your front speakers normally.

Bi-Amp:

Select this if you've connected your front speakers for bi-amped operation.

5



Press the [Setup] button.

Setup closes.

Note:

This procedure can also be performed on the AV controller by using its [Setup] button, arrow buttons, and [Enter] button.

TV Format Setup (not North American models)

For the onscreen setup menus to display properly, you must specify the TV system used in your area.

1



Press the [Receiver] button, followed by the [Setup] button.

The main menu appears onscreen.

If the main menu doesn't appear, make sure the appropriate external input is selected on your TV.

2

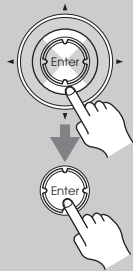

Use the Up and Down [▲]/[▼] buttons to select “6. Miscellaneous”, and then press [Enter].

The “Miscellaneous” menu appears.

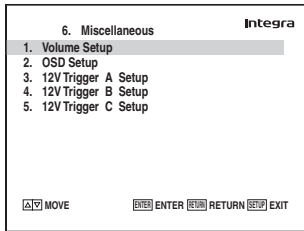

3



Use the Up and Down [▲]/[▼] buttons to select “2. OSD Setup”, and then press [Enter].

The “OSD Setup” menu appears.

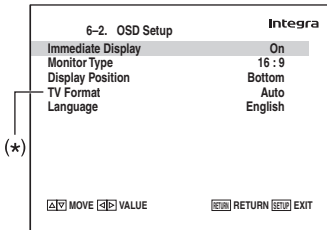

Note:

The “TV Format” (*) setting is not available on the North American models.

4

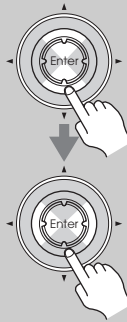

Use the Up and Down [▲]/[▼] buttons to select “TV Format”, and then use the Left and Right [◀]/[▶] buttons to select:

Auto: Select this to have the AV controller automatically detect the TV system from the video input signals.

NTSC: Select if the TV system in your area is NTSC.

PAL: Select if the TV system in your area is PAL.

5



Press the [Setup] button.
Setup closes.

Note:

This procedure can also be performed on the AV controller by using its [Setup] button, arrow buttons, and [Enter] button.

AM Frequency Step Setup (on some models)

For AM tuning to work properly, you must specify the AM frequency step used in your area. Note that when this setting is changed, all radio presets are deleted.

1 Press the [Receiver] button, followed by the [Setup] button. The main menu appears onscreen. If the main menu doesn't appear, make sure the appropriate external input is selected on your TV.



2 Use the Up and Down [▲]/[▼] buttons to select "7. Hardware Setup", and then press [Enter]. The "Hardware Setup" menu appears.



Integra

7. Hardware Setup

- 1. Remote Control
- 2. Zone2/Zone3
- 3. Tuner
- 4. Analog Multich
- 5. HDMI
- 6. Network

[MOVE] MOVE [ENTER] ENTER [RETURN] RETURN [EXIT] EXIT

3 Use the Up and Down [▲]/[▼] buttons to select "3. Tuner", and then press [Enter]. The "Tuner" menu appears.



Integra

7-3. Tuner

AM Freq Step 9kHz

[VALUE] VALUE [RETURN] RETURN [EXIT] EXIT

4 Use the Up and Down [▲]/[▼] buttons to select "AM Freq Step", and then use the Left and Right [◀]/[▶] buttons to select:

10kHz: Select if 10 kHz steps are used in your area.

9kHz: Select if 9 kHz steps are used in your area.

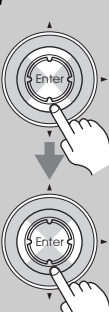

5 Press the [Setup] button. Setup closes.



Note: This procedure can also be performed on the AV controller by using its [Setup] button, arrow buttons, and [Enter] button.

Changing the Input Display

If you connect an **RI**-capable Onkyo MiniDisc recorder, CD recorder, or RI Dock to the TAPE IN/OUT jacks, or connect an RI Dock to the AUX 1 jacks, for **RI** to work properly, you must change this setting.

This setting can only be changed on the AV controller.

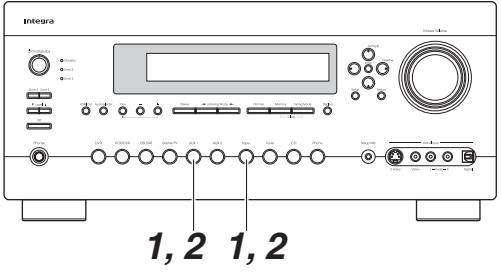

1 Press the [Tape] or [AUX 1] input selector button so that "TAPE" or "AUX1" appears on the display.

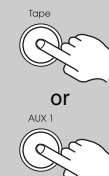

TAPE

or

AUX 1

2 Press and hold down the [Tape] or [AUX 1] input selector button (about 3 seconds) to change the setting.

(3 seconds) Repeat this step to select MD, CDR, or DOCK.

or

(3 seconds) For the Tape input selector, the setting changes in this order:

TAPE → MD → CDR

 ↑ ↓

 DOCK

For the AUX 1 input selector, the setting changes in this order:

AUX1 ↔ DOCK

Note: DOCK can be selected for the Tape input selector or AUX 1 input selector, but not both at the same time.

**Automatic Speaker Setup
(Audyssey MultEQ® XT)**

With the supplied calibrated microphone, Audyssey MultEQ XT automatically determines the number of speakers connected, their size for purposes of bass management, optimum crossover frequencies to the subwoofer (if present), and distances from the primary listening position.

Audyssey MultEQ XT then removes the distortion caused by room acoustics by capturing room acoustical problems over the listening area in both the frequency and time domain. The result is clear, well-balanced sound for everyone. Enabling Audyssey MultEQ XT allows you to also use Audyssey Dynamic EQ™, which maintains the proper octave-to-octave balance at any volume level.

Before using this function, connect and position all of your speakers.

About Audyssey Dynamic Volume

Audyssey Dynamic Volume solves the problem of large variations in volume level between television programs, commercials, and between the soft and loud passages of movies. Dynamic Volume looks at the preferred volume setting by the user and then monitors how the volume of program material is being perceived by listeners in real time to decide whether an adjustment is needed. Whenever necessary, Dynamic Volume makes the necessary rapid or gradual adjustments to maintain the desired playback volume level while optimizing the dynamic range. Audyssey Dynamic EQ is integrated into Dynamic Volume so that as the playback volume is adjusted automatically, the perceived bass response, tonal balance, surround impression, and dialog clarity remain the same whether watching movies, flipping between television channels, or changing from stereo to surround sound content.

About Audyssey Dynamic EQ

Audyssey Dynamic EQ solves the problem of deteriorating sound quality as volume is decreased by taking into account human perception and room acoustics. Dynamic EQ selects the correct frequency response and surround levels moment-by-moment at any user-selected volume setting. The result is bass response, tonal balance, and surround impression that remain constant despite changes in volume. Dynamic EQ combines information from incoming source levels with actual output sound levels in the room, a prerequisite for delivering a loudness correction solution. Audyssey Dynamic EQ works in tandem with Audyssey MultEQ to provide well-balanced sound for every listener at any volume level.

Measurement Positions

To create a listening environment in your home theater that all listeners will enjoy, Audyssey MultEQ® takes measurements at up to eight positions within the listening area.

■ **1st measurement position**

This is the center position of your listening area, or the listening position if there's only one listener.

■ **2nd–8th measurement positions**

These are the other listening positions (i.e., the places where the other listeners will sit). You can measure up to eight positions.

The following examples show some typical home theater seating arrangements. Choose the one that best matches yours, and position the microphone accordingly when prompted.

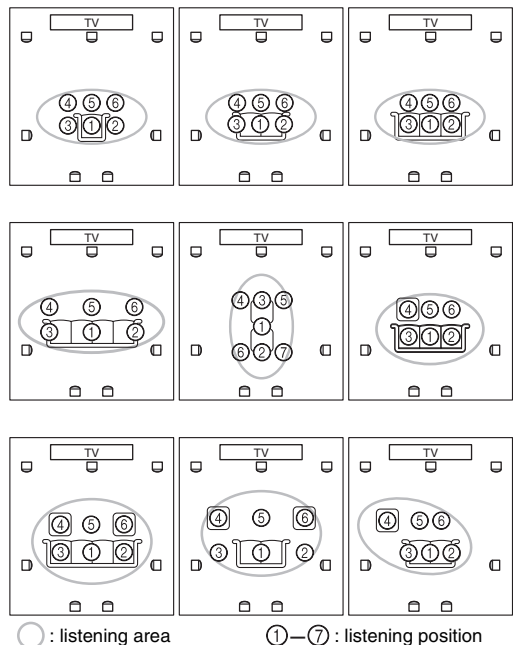

Using Audyssey MultEQ® XT

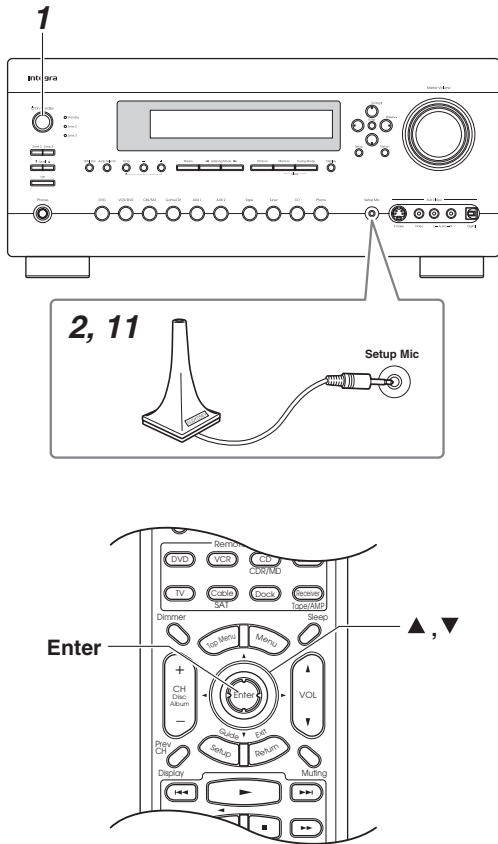

Notes:

- If the AV controller is muted, it will be unmuted automatically when the automatic speaker setup starts.
- Automatic speaker setup cannot be performed while a pair of headphones is connected.
- It takes about 15 minutes to complete the automatic speaker setup for three positions. Total measurement time varies depending on the number of positions and speakers.
- Do not disconnect the speaker setup microphone during the automatic speaker setup, unless you want to cancel the setup.
- Do not connect or disconnect any speakers during the automatic speaker setup.

The onscreen menus shown in this manual may be slightly different from what you see on your TV.

1

Turn on the AV controller and the connected TV.

On the TV, select the input to which the AV controller is connected.

2

Setup Mic



Place the speaker setup microphone at measurement point ① (page 58), and connect it to the Setup Mic jack.

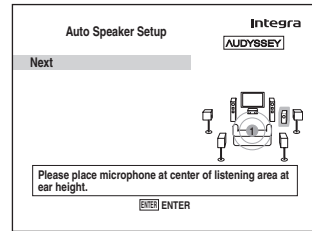

Notes:

- Before starting Audyssey MultEQ® XT Automatic Speaker Setup, arrange the room and connect the speakers as you would for enjoying movies. Changes to the room after auto setup requires you run the auto setup again, as room EQ characteristics may have changed.
- When starting the automatic speaker setup, do not stand between the speakers and microphone, and avoid obstacles blocking the path between speakers and microphone. This will produce inaccurate results.
- Position the microphone at ear height of a seated listener with the microphone tip pointed directly at the ceiling using a tripod. Do not hold the microphone in your hand during measurements as this will produce inaccurate results.
- Make the room as quiet as possible. Background noise can disrupt the room measurements. Close windows, silence cell phones, televisions, radios, air conditioners, fluorescent lights, home appliances, light dimmers, or other devices.
- Cell phones should be turned off or placed away from all audio electronics during the measurement process as Radio Frequency Interference (RFI) may cause measurement disruptions (even if the cell phone is not in use).

3



Press [Enter].
The automatic speaker setup starts.

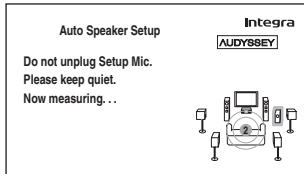

Test tones are played through each speaker as Audyssey MultEQ[®] XT Automatic Speaker Setup runs. This process takes a few minutes. Please refrain from talking during measurements and do not stand between speakers and the microphone.

4

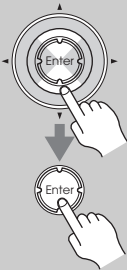

The speaker detect results appear.

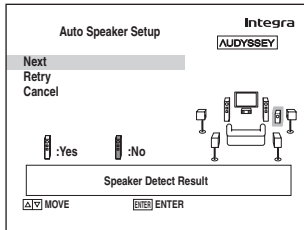

“Yes” means that the speaker was detected. “No” means that no speaker was detected.

If you agree with the results, use the Up and Down [▲]/[▼] buttons to select “Next”, and then press [Enter].

The options are:

Next: Proceed to the next step.

Retry: Return to step 2 and try again.

Cancel: Cancel the automatic speaker setup.

5

The following screen appears.

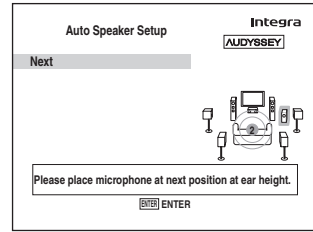

Place the setup microphone at the next position (see page 58), and then press [Enter].

Audyssey MultEQ[®] XT performs more measurements. This takes a few minutes.

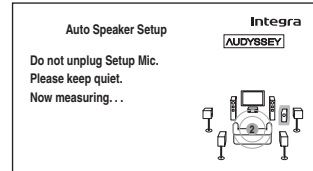

6

When prompted, place the setup microphone at the next position, and repeat step 5.

7

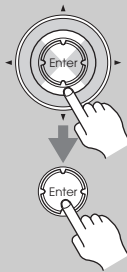

After the 3rd or 7th measurement, the following screen appears.

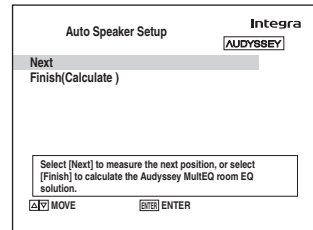

Use the Up and Down [▲]/[▼] buttons to select an option, and then press [Enter].

Next:

Select “Next” to begin measuring the next measurement position.

After the 8th measurement has been taken, the procedure automatically proceeds to step 8.

Finish(Calculate):

Select this if you don’t want to measure any more listening positions and are ready to calculate the results, then go to step 8.

8

When the measurements are complete, the following screen appears.

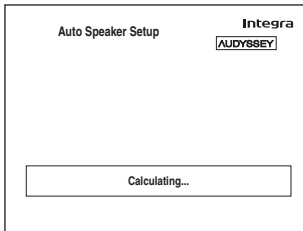

9

When the calculations are complete, the following screen appears.

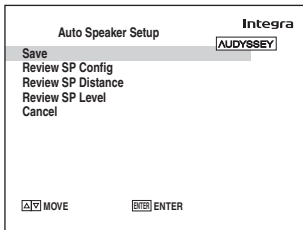
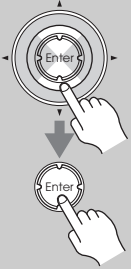

Use the Up and Down [▲]/[▼] buttons to select an option, and then press [Enter].

Save:

Save the calculated settings and exit the automatic speaker setup.

Review SP Config:

Review the speaker configuration settings (see “Reviewing the Results” on page 63).

Review SP Distance:

Review the speaker distance settings (see “Reviewing the Results” on page 63).

Review SP Level:

Review the speaker level settings (see “Reviewing the Results” on page 63).

Cancel:

Cancel the automatic speaker setup.

10

If you selected “Save”, the results are saved, and the following screen appears.

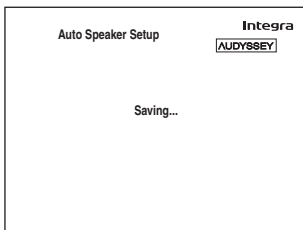

11

Disconnect the setup Mic.

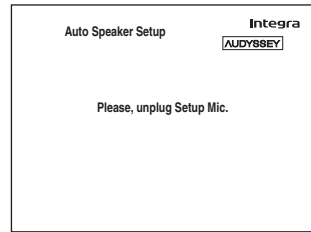

Notes:

- When the automatic speaker setup is complete, the “Equalizer Settings” (page 110) will be set to Audyssey.
- You can cancel the automatic speaker setup at any point in the procedure simply by disconnecting the setup microphone.

Error Messages

While the automatic speaker setup is in progress, one of the following error messages may appear:

❑ Ambient noise is too high

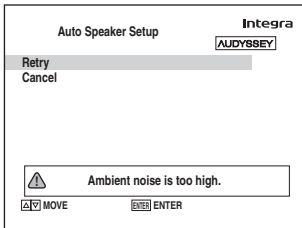

This message appears if the background noise is too loud and the measurements cannot be performed properly.

Remove the source of the noise and try again.

Retry: Return to the measured point immediately before and start set up again.

Cancel: Cancel the automatic speaker setup.

❑ Speaker Detect Error

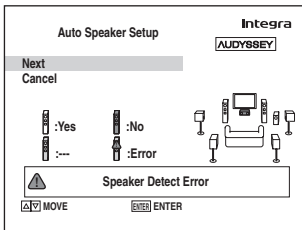

This message appears if a speaker is not detected. “Yes” means that a speaker was detected. “No” means that no speaker was detected. Check your speaker connections and retry, or cancel the automatic speaker setup.

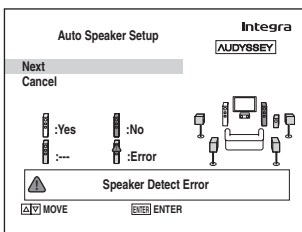

The front right speaker has not been detected.

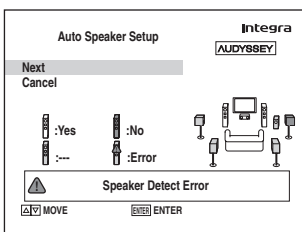

The surround right speaker has not been detected.

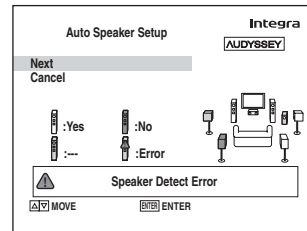

The surround back left speaker has not been detected.

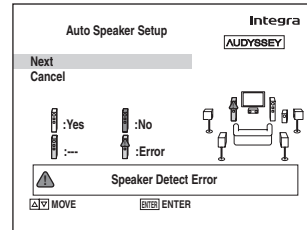

There is a problem with the front left speaker. If the warning triangle (▲) appears for the subwoofer, it may be that the output from the subwoofer is too loud.

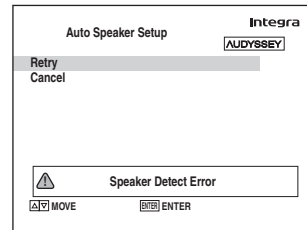

The number of speakers detected on the second or third measurement was different to the number detected on the first measurement.

Make sure speakers that cannot be detected are connected properly.

Retry: Return to step 2 and try again.

Cancel: Cancel the automatic speaker setup.

❑ Writing Error!

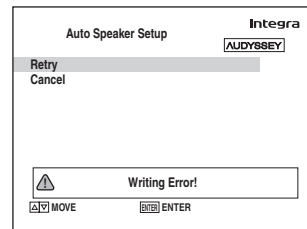

This message appears if saving fails.

Try saving again. If this message appears after 2 or 3 attempts, the AV controller is probably malfunctioning. Contact your Onkyo dealer.

Retry: Return to step 2 and try again.

Cancel: Cancel the automatic speaker setup.

Reviewing the Results

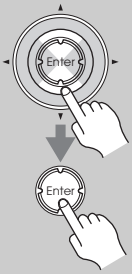

Use the Up and Down [▲]/[▼] buttons to select the settings that you want to review, and then press [Enter].

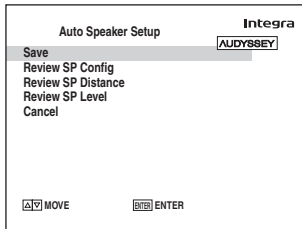

The options are:

Review SP Config

Review the speaker configuration settings.

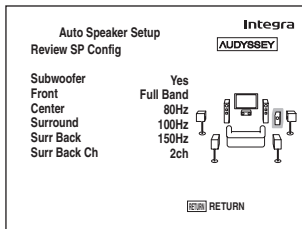

Review SP Distance

Review the speaker distance settings.

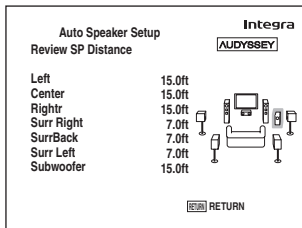

Review SP Level

Review the speaker level settings.

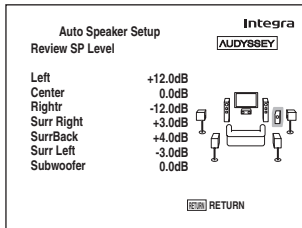

Press [Return] to return to the previous screen.

Changing the Speaker Settings Manually

In rare situations, proper measurements taken may not be obtainable by the automatic speaker setup. For example, there may be too much noise in the room. If running the speaker setup a second time is still unsuccessful you will have to set the speaker settings manually. (see pages 104–110).

Notes:

- For THX-certified speakers, the 80 Hz (THX) crossover frequency is recommended. If you use the automatic speaker setup, you'll need to manually select 80 Hz (THX) for each THX-certified speaker (see page 104).
- Because of the complexities of low-frequency sounds and the way they interact with a room, THX recommends setting the subwoofer level and distance manually.

Using a Powered Subwoofer

If you're using a powered subwoofer and it outputs very low-frequency sound at a low volume level, it may not be detected by the automatic speaker setup.

If the "Subwoofer" appears on the "Review SP Config" screen as "No", increase the subwoofer's volume to the half-way point, set it to its highest crossover frequency, and then try running the automatic speaker setup again. Note that if the volume is set too high and the sound distorts, detection issues may occur, so use an appropriate volume level. If the subwoofer has a low-pass filter switch, set it to Off or Direct. Refer to your subwoofer's instruction manual for details.

Basic Operations

Selecting the Input Source

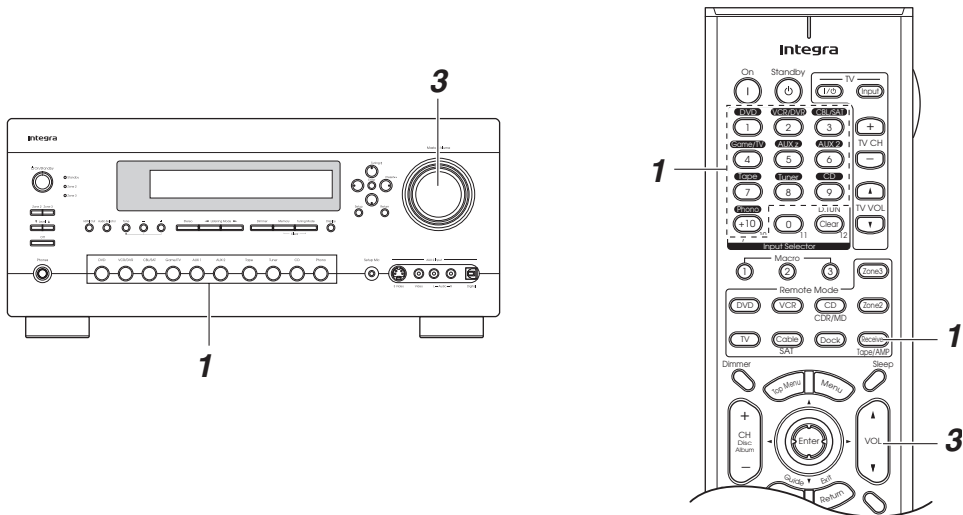

1

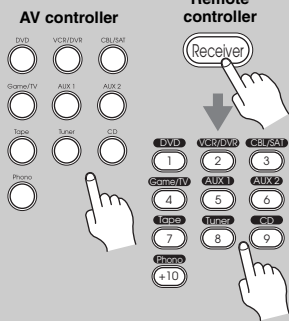

Use the AV controller's input selector buttons to select an input source.

To select an input source with the remote controller, press its [Receiver] Remote Mode button, and then use its Input Selector buttons.

2

Start playback on the source component.

When you select DVD or another video component, on your TV, you'll need to select the video input that's connected to the AV controller's COMPONENT VIDEO MONITOR OUT 1, COMPONENT VIDEO MONITOR OUT 2/ZONE 2 OUT, HDMI OUT MAIN, HDMI OUT SUB, or MONITOR OUT.

On some DVD players, you may need to turn on the digital audio output.

3

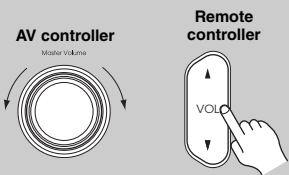

To adjust the volume, use the Master Volume control, or the remote controller's VOL [▲]/[▼] button.

The volume can be set to $-\infty$ dB, -81.5 dB through $+18.0$ dB (relative display).

The AV controller is designed for home theater enjoyment. It has a wide volume range, allowing precise adjustment.

The volume level can also be displayed as an absolute value. See "Volume Setup" on page 123.

4

Select a listening mode and enjoy!

See "Using the Listening Modes" on page 90.

Basic Operations—Continued

This section explains functions that can be used with any input source.

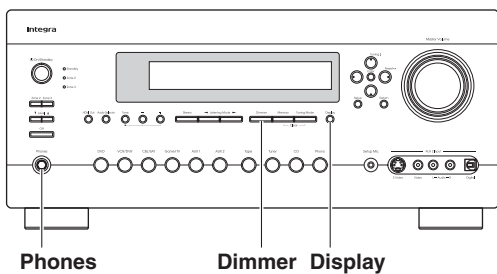
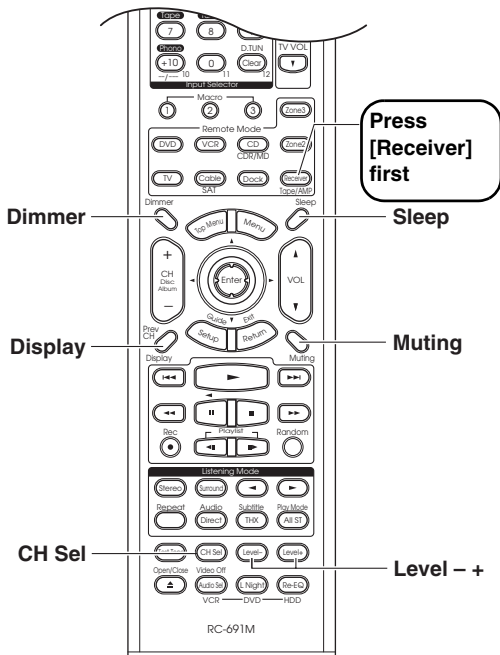

Setting the Display Brightness

You can adjust the brightness of the display.

Remote controller
Dimmer



AV controller
Dimmer



Press the remote controller's [Dimmer] button repeatedly to select: Normal, Dim, or Dimmer.

You can also use the AV controller's [Dimmer] button (not Australian models).

Adjusting Speaker Levels

You can adjust the volume of each speaker while listening to an input source. These temporary adjustments are cancelled when the AV controller is set to Standby.

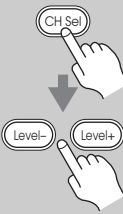

Use the remote controller's [CH Sel] button to select each speaker, and use the [Level-] and [Level+] buttons to adjust the volume.

You can adjust the volume of each speaker from -12 dB to +12 dB (-15 dB to +12 dB for the subwoofer).

Left : 0.0dB

Notes:

- You cannot use this function while the AV controller is muted.
- Speakers that are set to "No" or "None" in the "Speaker Config" cannot be adjusted (see page 104).

Headphones

While a pair of headphones is connected, you can use the [CH Sel], [Level-], and [Level+] buttons to adjust the volume of each headphone speaker (left and right), from -12 dB to +12 dB each.

HP Left : -3.5dB

These settings are stored when the AV controller is set to Standby.

Muting the AV Controller

You can temporarily mute the output of the AV controller.



Muting

Press the remote controller's [Muting] button.

The output is muted and the MUTING indicator flashes on the display, as shown.



To unmute the AV controller, press the [Muting] button again, or adjust the volume.

The Mute function is cancelled when the AV controller is set to Standby.

Tip:

You can specify how much the output is muted with the "Muting Level" setting (see page 123).

Using the Sleep Timer

With the sleep timer, you can set the AV controller to turn off automatically after a specified period.



Press the [Receiver] button, and then press the [Sleep] button repeatedly to select the required sleep time.

The sleep time can be set from 90 to 10 minutes in 10 minute steps.

The SLEEP indicator appears on the display when the sleep timer has been set. The specified sleep time appears on the display for about five seconds, then the previous display reappears.

If you need to cancel the sleep timer, press the [Sleep] button repeatedly until the SLEEP indicator disappears.

To check the time remaining until the AV controller sleeps, press the [Sleep] button. Note that if you press the [Sleep] button while the sleep time is being displayed, you'll shorten the sleep time by 10 minutes.

Using Headphones

For private listening, you can connect a pair of stereo headphones (1/4-inch phone plug) to the AV controller's Phones jack.

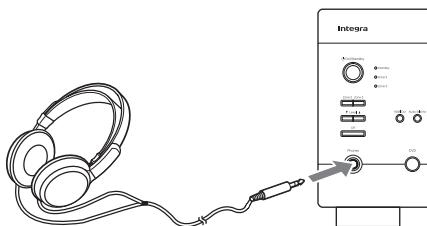

Notes:

- Always turn down the volume before connecting your headphones.
- While the headphones plug is inserted in the Phones jack, the speakers are turned off and the Headphone indicator lights up.
- When you connect a pair of headphones, the listening mode is set to Stereo, unless it's already set to Stereo, Mono, or Direct.
- Only the Stereo, Direct, and Mono listening modes can be used with headphones (the listening modes available also depend on the currently selected input source).
- When the multichannel input is used, only the front left and right audio can be heard in the headphones.

Adjusting the Bass & Treble

You can adjust the bass and treble for the front speakers, except when the Direct or THX listening mode is selected.



1 Press the AV controller's [Tone] button repeatedly to select Bass or Treble for Front, Center, Surround, SurrBack, or Subwoofer.

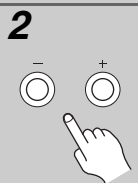

2 Use the Tone Plus [+] and Minus [-] buttons to adjust.

■ Bass

You can boost or cut low-frequency sounds output by the front speakers from -10 dB to +10 dB in 1 dB steps.

■ Treble

You can boost or cut high-frequency sounds output by the front speakers from -10 dB to +10 dB in 1 dB steps.

Notes:

- This setting is not available when the multichannel Analog input is selected.
- The tone control settings do not apply to the Direct, or THX listening modes.

Displaying Source Information

You can display various information about the current input source as follows.

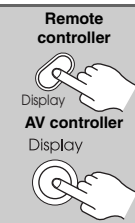

Press the [Display] button repeatedly to cycle through the available information.

The following information can typically be displayed:

Input source	—DVD
Listening mode	—Pure Audio
	↓ ↑
Signal format*	—DTS-HDMSTR 5.1
Sampling frequency	—fs: 96 kHz

* If the input signal is analog, no format information is displayed. If the input signal is PCM, the sampling frequency is displayed. If the input signal is digital but not PCM, the signal format and the number of channels is displayed. For some digital input signals, including multichannel PCM, the signal format, number of channels, and sampling frequency is displayed. Information is displayed for about three seconds, then the previously displayed information reappears.

Listening to the Radio

Listening to AM/FM Stations

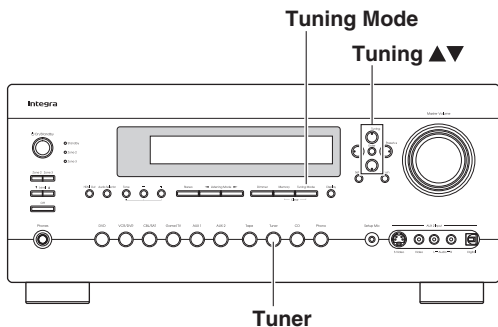

With the built-in tuner, you can enjoy AM and FM radio stations and store your favorite stations as presets for easy selection.



Use the [Tuner] input selector button to select AM or FM.

In this example, FM has been selected.

Band	Frequency
FM	87.5 MHz

(Actual display depends on country.)

Manual Tuning Mode

1

Tuning Mode

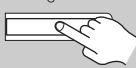

Press the [Tuning Mode] button so that the AUTO indicator disappears from the display.

2

Tuning ▲▼

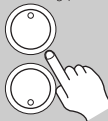

Press and hold the Tuning Up or Down [▲]/[▼] button.

The frequency stops changing when you release the button.

Press the button repeatedly to change the frequency one step at a time.

The North American model changes FM frequency in 0.2 MHz steps, 10 kHz steps for AM. For other models it's 0.05 MHz steps for FM and 9 kHz steps for AM. In Manual Tuning mode, FM stations will be in mono.

Tuning into Weak FM Stereo Stations

If the signal from a stereo FM station is weak, it may be impossible to get good reception. In this case, switch to Manual Tuning mode and listen to the station in mono.

Tuning into AM/FM Radio Stations

Auto Tuning Mode

1

Tuning Mode

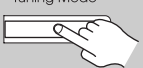

Press the [Tuning Mode] button so that the AUTO indicator appears on the display.

2

Tuning ▲▼

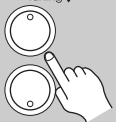

Press the Tuning Up or Down [▲]/[▼] button.

Searching stops when a station is found.

When tuned into a station, the TUNED indicator appears. When tuned into a stereo FM station, the FM STEREO indicator also appears. (The FM STEREO indicator will not appear on models that have HD Radio reception.)

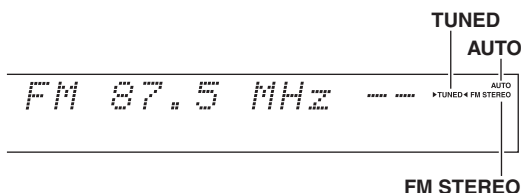

Listening to the Radio—Continued

■ Tuning into Stations by Frequency

You can tune into AM and FM stations directly by entering the appropriate frequency.

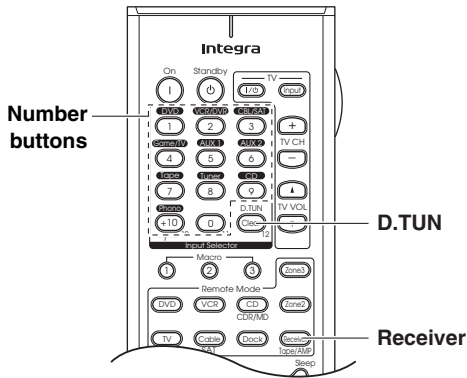

Displaying AM/FM Radio Information

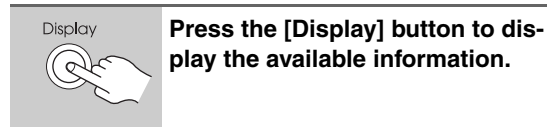
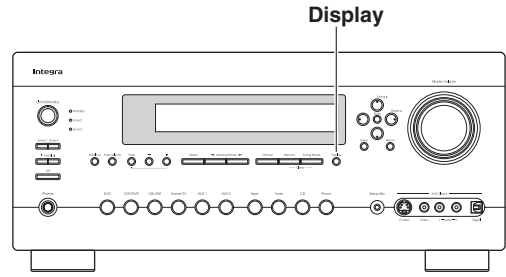

1



Press the [Receiver] button, followed by the [D.TUN] button.

The [Receiver] button flashes.

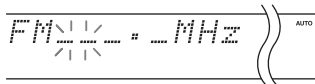

(Actual display depends on country.)

2



Within 8 seconds, use the number buttons to enter the frequency of the radio station.

For example, to tune to 87.5 (FM), press 8, 7, 5.

Note:

While the [Receiver] button is flashing, you cannot select another input source with the remote controller.

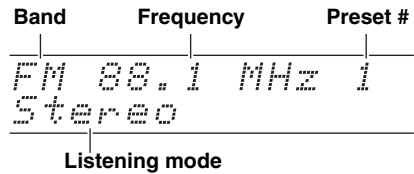

Note:

When you select a preset with a custom name (see page 118), its name is displayed instead of the band and frequency.

Presetting AM, FM, XM, and SIRIUS Stations

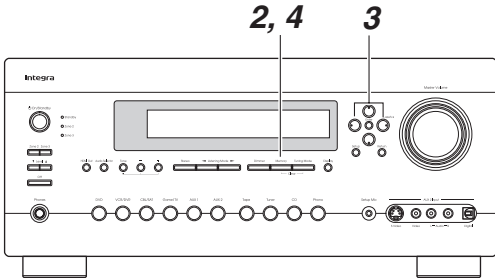

You can store a combination of up to 40 of your favorite AM and FM radio stations.

1 Tune into the AM, FM, XM, or SIRIUS station you want to store as a preset.

2 Press the [Memory] button. The preset number flashes.

Memory



3 While the preset number is flashing (about 8 seconds), use the Preset [◀]/[▶] buttons to select a preset from 1 through 40.

Preset◀▶



4 Press the [Memory] button again to store the station.

Memory

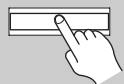

The station is stored and the preset number stops flashing. Repeat this procedure for all of your favorite stations.

Note:

You can name your radio presets for easy identification (see page 118).

Selecting Presets

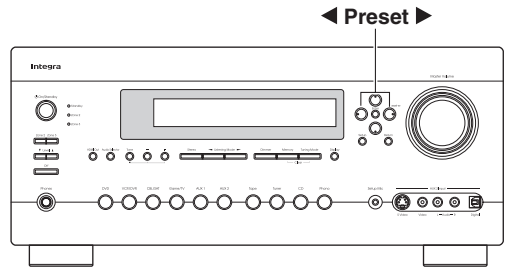

CH +/-

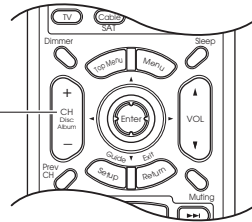

To select a preset, use the Preset [◀]/[▶] buttons or the remote controller's CH [+/-] button.

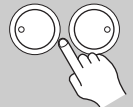

Deleting Presets

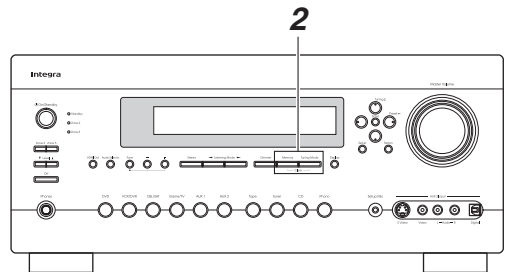

1 Select the preset that you want to delete. See the previous section.

2 While holding down the [Memory] button, press the [Tuning Mode] button.

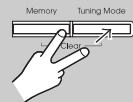

The preset is deleted and its number disappears from the display.

Listening to HD Radio™ Stations (North American model only)

HD Radio technology brings digital radio to conventional analog AM and FM radio stations, with improved sound quality, better reception, and new data services. HD Radio technology provides CD-quality sound for FM stations and FM-quality sound for AM stations. In addition, FM HD Radio stations can transmit multiple programs on the same frequency by using multicast channels. Text data display includes station name, song title, artist name, and so on.

For more information about HD Radio technology, visit:
www.ibiquity.com
www.hdradio.com

About HD Radio Stations

HD Radio stations broadcast on the same AM and FM frequencies they've always used, and you can receive them by tuning into your favorite station as normal (see page 67). You can store them as presets just like AM and FM stations (see page 69).

If the current AM or FM station supports HD Radio technology, the HD indicator lights up.

While a digital HD Radio transmission is being received, the DIGITAL indicator lights up. While an analog HD Radio transmission is being received, the ANALOG indicator lights up.

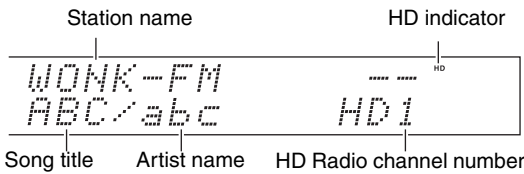

- If the current AM or FM station supports HD Radio technology, the station's name will be displayed instead of the band and frequency.
- When music data is received, song title and artist name information is displayed.
- If the current HD Radio station supports multicast channels, the name of the currently selected multicast channel will be displayed.

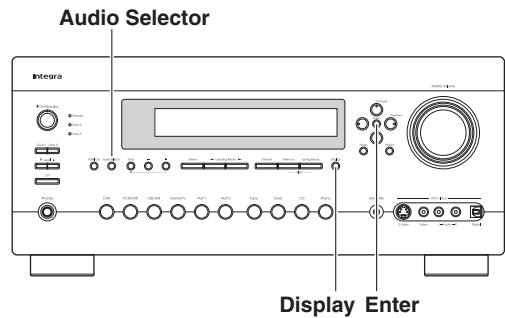
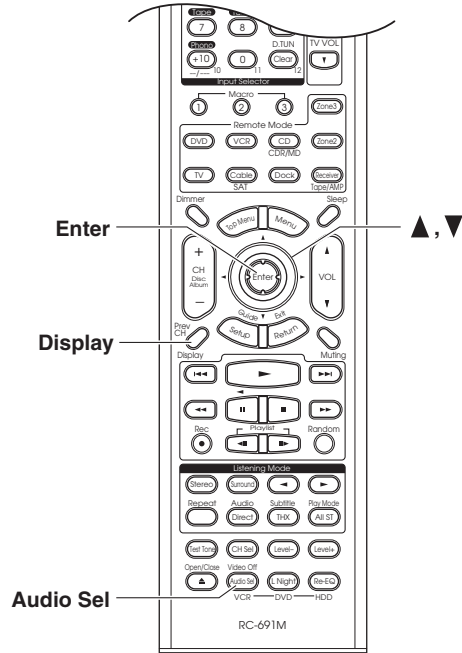

Listening to the Radio—Continued

Selecting Multicast Channels

FM HD Radio stations can transmit multiple programs on the same frequency by using what are called *multicast channels*. If the current HD Radio station is broadcasting multicast channels, the SPS (secondary program services) indicator lights up.

1



Press [Enter].

The SPS indicator flashes.

2

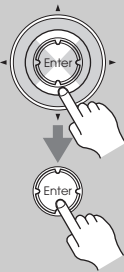

Use the Up and Down Arrow [▲]/[▼] buttons to select a multicast channel.

If you select a multicast channel that is not currently broadcasting, a plus [+] symbol will appear, indicating that the channel has been reserved. When broadcasting commences, that channel will be selected automatically.

```
WONK-FM      --
Reserve      +HD4
```

Reserved channel indication
HD Radio channel number

Within 5 seconds, press [Enter] to set the multicast channel.

Note:

Multicast channels are not available on AM.

Note:

Multicast channels 2 through 8 only carry a digital signal, so to select an audio format, you must select multicast channel #1 first.

Displaying HD Radio Information

Press the [Display] button repeatedly to cycle through the available information.

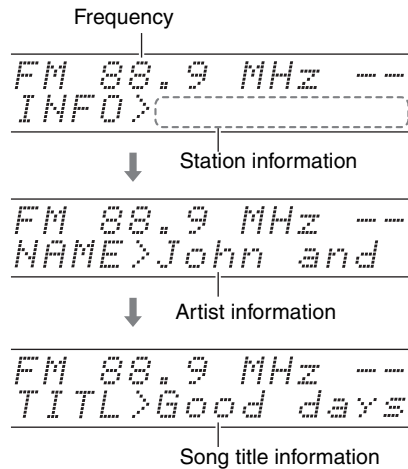

Selecting the Audio Format (Blend Mode)

HD Radio stations transmit both analog and digital versions of their programs and you can choose which one you want to listen to.

Remote controller



Use the [Audio Sel] button to select “Auto” or “Analog”.

```
Blend Mode --
# Analog
```



```
Auto
```

Auto: Select to use the digital signal.

Analog: Select to use the analog signal.

AV controller
Audio Selector



Using RDS

RDS only works in areas where RDS broadcasts are available. When tuned to an RDS station, the RDS indicator appears.

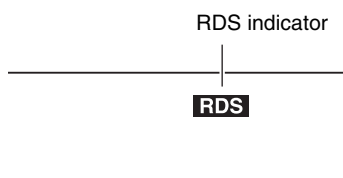

■ What is RDS?

RDS stands for *Radio Data System* and is a method of transmitting data in FM radio signals. It was developed by the European Broadcasting Union (EBU) and is available in most European countries. RDS is approved by the National Radio Systems Committee (NRSC) and is available in North America.

Many FM stations use it these days. In addition to displaying text information, RDS can also help you find radio stations by type (e.g., news, sport, rock, etc.).

The AV controller supports four types of RDS information:

PS (Program Service)

When tuned to an RDS station that's broadcasting PS information, the station's name will be displayed. Pressing the [Display] button will display the frequency for 3 seconds.

RT (Radio Text)

When tuned to an RDS station that's broadcasting text information, the text will be shown on the display (see page 73).

PTY (Program Type)

This allows you to search RDS radio stations by type (see page 73).

TP (Traffic Program)

This allows you to search for RDS radio stations that broadcast traffic information (see page 73).

Notes:

- In some cases, the characters displayed on the AV controller may not be identical to those broadcast by the radio station. Also, unexpected characters may be displayed when unsupported characters are received. This is not a malfunction.
- If the signal from an RDS station is weak, RDS data may be displayed intermittently or not at all.

RDS Program Types (PTY)

Type	Display
None	NONE
News reports	NEWS
Current affairs	AFFAIRS
Information	INFO
Sport	SPORT
Education	EDUCATE
Drama	DRAMA
Culture	CULTURE
Science and technology	SCIENCE
Varied	VARIED
Pop music	POP M
Rock music	ROCK M
Middle of the road music	EASY M
Light classics	LIGHT M
Serious classics	CLASSICS
Other music	OTHER M
Weather	WEATHER
Finance	FINANCE
Children's programmes	CHILDREN
Social affairs	SOCIAL
Religion	RELIGION
Phone in	PHONE IN
Travel	TRAVEL
Leisure	LEISURE
Jazz music	JAZZ
Country music	COUNTRY
National music	NATION M
Oldies music	OLDIES
Folk music	FOLK M
Documentary	DOCUMENT
Alarm test	TEST
Alarm	ALARM

Listening to the Radio—Continued

Displaying Radio Text (RT)

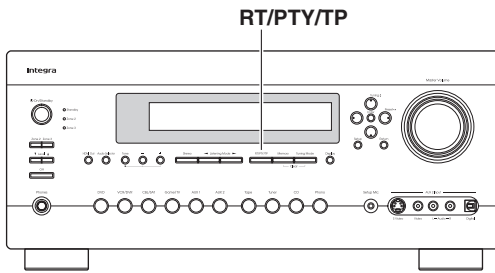

When tuned to an RDS station that's broadcasting text information, the text can be displayed.

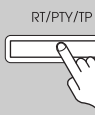

Press the [RT/PTY/TP] button once.

The RT information scrolls across the display.

Notes:

- The message "Waiting" may appear while the AV controller waits for the RT information.
- If the message "No Text Data" appears on the display, no RT information is available.

Finding Stations by Type (PTY)

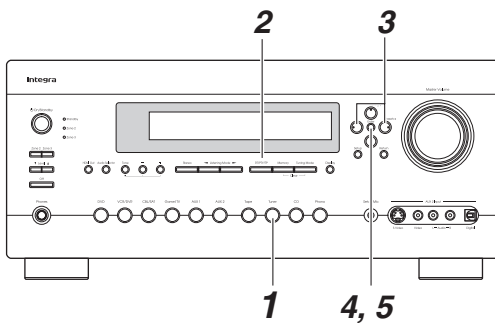

You can search for radio stations by type.

1



Use the [Tuner] input selector button to select FM.

2



Press the [RT/PTY/TP] button twice.

The current program type appears on the display.

3

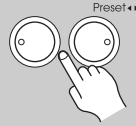

Use the Preset [◀]/[▶] buttons to select the type of program you want.

See the table on page 72.

4



To start the search, press [Enter].

The AV controller searches until it finds a station of the type you specified, at which point it stops briefly before continuing with the search.

5



When a station you want to listen to is found, press [Enter].

If no stations are found, the message "Not Found" appears.

Listening to Traffic News (TP)

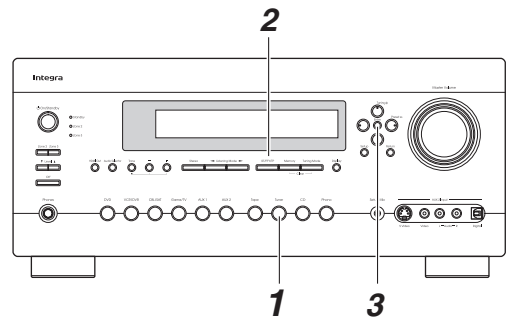

You can search for stations that broadcast traffic news.

1



Use the [Tuner] input selector button to select FM.

2

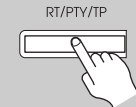

Press the [RT/PTY/TP] button three times.

If the current radio station is broadcasting TP (Traffic Program), "[TP]" will appear on the display and traffic news will be heard as and when it's broadcast. If "TP" without square brackets appears, this means that the station is not broadcasting TP.

3



To locate a station that is broadcasting TP, press [Enter].

The AV controller searches until it finds a station that's broadcasting TP. If no stations are found, the message "Not Found" appears.

Listening to XM Satellite Radio® (North American Model Only)

About XM Radio

XM is North America's number one satellite radio company, offering an extraordinary variety of commercial-free music, plus the best in premier sports, news, talk radio, comedy, children's and entertainment programming, broadcast in superior digital audio quality coast to coast. For more information, or to subscribe, U.S. customers visit xmradio.com or call XM Listener Care at 1-800-XMRADIO (1-800-967-2346); Canadian customers visit xmradio.ca or call XM Listener Care at 1-877-GETXMSR (1-877-438-9677).

XM Ready® Legal

XM monthly service subscription sold separately. XM Mini-Tuner and Home Dock required (each sold separately) to receive XM service. It is prohibited to copy, decompile, disassemble, reverse engineer, hack, manipulate or otherwise make available any technology or software incorporated in receivers compatible with the XM satellite Radio System. Installation costs and other fees and taxes, including a one-time activation fee may apply. All fees and programming subject to change. Channels with frequent explicit language are indicated with an XL. Channel blocking is available for XM radio receivers by calling 1-800-XMRADIO (U.S. residents) and 1-877-GETXMSR (Canadian residents). Only available in the 48 contiguous United States and Canada. ©2007 XM Satellite Radio Inc. All rights reserved.

XM Ready® Subscription

Once you have installed the XM Mini-Tuner Home Dock, inserted the XM Mini-Tuner, connected the XM Mini-Tuner Home Dock to your XM Ready® audio system, and installed the antenna, you are ready to subscribe and begin receiving XM programming. There are three places to find your eight character XM Radio ID: On the XM Mini-Tuner, on the XM Mini-Tuner package, and on XM Channel 0. Record the Radio ID below for reference.

--	--	--	--	--	--	--	--

Note:

The XM Radio ID does not use the letters "T", "O", "S" or "F".

Activate your XM Satellite Radio service in the U.S. online at <http://activate.xmradio.com> or call 1-800-XMRADIO (1-800-967-2346). Activate your XM Satellite Radio service in Canada online at <https://activate.xmradio.ca> or call 1-877-GET-XMSR (1-877-438-9677). You will need a major credit card. XM will send a signal from the satellites to activate the full channel lineup. Activation normally takes 10-15 minutes, but during peak busy periods you may need to keep your XM Ready audio system on for up to an hour. When you can access the full lineup on your XM Ready audio system you are done.

Connecting the XM Mini-Tuner and Home Dock

To receive XM Satellite Radio, you need an XM Mini-Tuner and Home Dock, which includes a home antenna. These are sold separately. For connection information, refer to the instruction manual supplied with the XM Mini-Tuner and Home Dock.

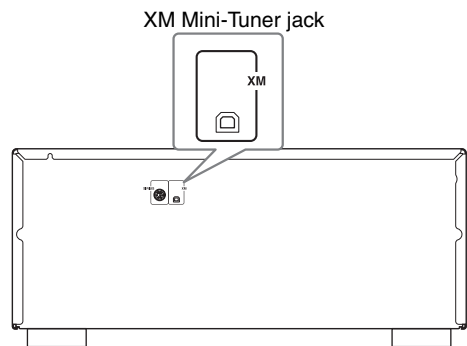

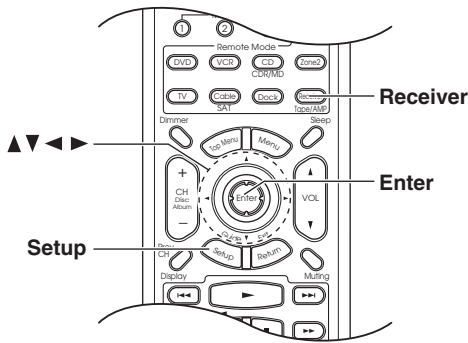

Setting the Satellite Radio Mode

Before you can listen to XM Satellite Radio, you must set the Satellite Radio mode to XM.

1

Press the [Receiver] Remote Mode button, followed by the [Setup] button.

The main menu appears onscreen.



2

Use the Up and Down [▲]/[▼] buttons to select “7. Hardware Setup”, and then press [Enter].

The “Hardware Setup” menu appears.

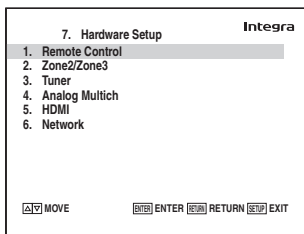

3

Use the Up and Down [▲]/[▼] buttons to select “3. Tuner”, and then press [Enter].

The “Tuner” screen appears.

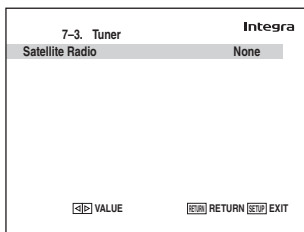

4

Use the Left and Right [◀]/[▶] buttons to select “XM”.

If there are 2 items on the Tuner screen, use Up and Down [▲]/[▼] buttons to select “Satellite Radio”.

Pressing the Left and Right [◀]/[▶] buttons cycles through the following options: None → XM → SIRIUS → XM/SIRIUS

None: Select if you're not using satellite radio.

XM: Select to use XM Satellite Radio.

SIRIUS: Select to use SIRIUS Satellite Radio.

XM/SIRIUS: Select to use XM Satellite Radio and SIRIUS Satellite Radio.



5

When you've finished, press the [Setup] button.

Setup closes.

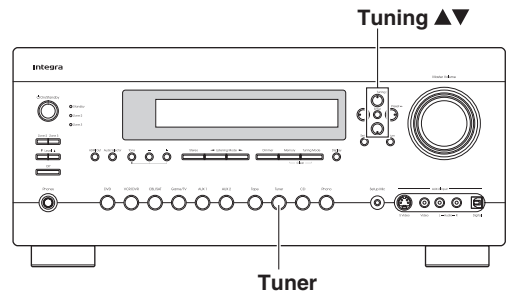

Selecting XM Satellite Radio

AV controller



On the AV controller, press the [Tuner] Input Selector button repeatedly to select XM.

Remote controller



On the remote controller, press the [Receiver] Remote Mode button, and then press the [Tuner] Input Selector button repeatedly to select XM.

If “CHECK XM TUNER” appears on the display, make sure the XM Mini-Tuner is connected properly.

Signing Up for XM Satellite Radio

Once you have installed the XM Mini-Tuner and Home Dock, you are ready to subscribe to XM Satellite Radio. You'll need a major credit card and your XM Radio ID. There are three places you can find your 8-character XM Radio ID:

1. On the XM Mini-Tuner
2. On the XM Mini-Tuner packaging
3. On XM Channel 0, as explained below

<p>1</p> <p>AV controller Tuning ↕</p> 	<p>Use the Tuning Up and Down [▲]/[▼] buttons to select RADIO ID.</p> <p>Your XM Radio ID number is displayed. Write it below for reference.</p> <p style="text-align: center;">ID _____</p>
<p>2</p>	<p>To sign up, go to: http://activate.xmradio.com Or call: 1-800-967-2346</p> <p>For XM Canada, go to: http://xmradio.ca Or call: 1-877-438-9677</p>

Notes:

- RADIO ID cannot be selected in Category Search mode. You must select Channel Search mode (see page 76).
- The following letters are not used in XM Satellite Radio IDs: I, O, S, F.
- XM Satellite Radio will transmit a special signal to your AV controller to activate the full channel lineup. Activation normally takes between 10 and 15 minutes, but during busy peak periods, you may need to leave the AV controller turned on for up to an hour.

Selecting XM Radio Channels

There are three ways to select XM radio channels:



1. **Channel Search mode:** select any channel.
2. **Category Search mode:** select channels by category.
3. **Direct tuning:** enter channel number.

Note:

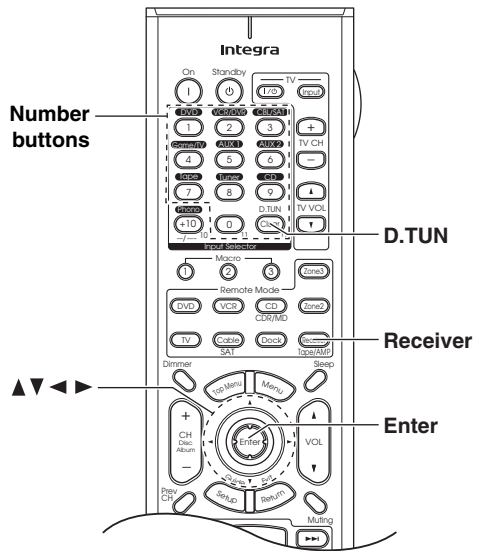

You can't select Channel Search mode or Category Search mode while the Tuning Arrow ▶ ◀ indicators are flashing, as tuning is in progress.



■ Channel Search Mode



<p>1</p> 	<p>Press the [Receiver] Remote Mode button, and then press the [Enter] button repeatedly to select Channel Search mode.</p> <p style="text-align: center; font-family: monospace;">ChannelSearch</p> <p>This procedure can also be performed on the AV controller by using its [Tuner] button, and [Tuning Mode] button.</p>							
<p>2</p> 	<p>Use the Up and Down [▲]/[▼] buttons to select a channel.</p> <table style="margin-left: auto; margin-right: auto; border-collapse: collapse;"> <tr> <td style="text-align: center;">Channel number</td> </tr> <tr> <td style="text-align: center;"> </td> </tr> <tr> <td style="text-align: center;">XM 050 5</td> </tr> <tr> <td style="text-align: center;"> </td> </tr> <tr> <td style="text-align: center;">The Loft</td> </tr> <tr> <td style="text-align: center;"> </td> </tr> <tr> <td style="text-align: center;">Channel name</td> </tr> </table> <p>You can also use the Left and Right [◀]/[▶] buttons to select a category.</p>	Channel number		XM 050 5		The Loft		Channel name
Channel number								
XM 050 5								
The Loft								
Channel name								

■ Category Search Mode



<p>1</p> <p>Remote controller</p>  <p>↓</p> 	<p>Press the [Receiver] Remote Mode button, and then press the [Enter] button repeatedly to select Category Search mode.</p> <p><i>Category Search</i></p> <p>This procedure can also be performed on the AV controller by using its [Tuner] button, and [Tuning Mode] button.</p>
<p>2</p> 	<p>Use the Left and Right [◀]/[▶] buttons to select a category, and use the Up and Down [▲]/[▼] buttons to select a channel in that category.</p>

■ Direct Tuning

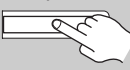

You can select an XM radio channel directly by entering its number.

<p>1</p> <p>Remote controller</p>  <p>↓</p> 	<p>Press the [Receiver] Remote Mode button, followed by the [D.TUN] button.</p> <p>The [Receiver] button flashes.</p> <p><i>XM</i> </p>
<p>2</p> 	<p>Within 8 seconds, use the number buttons to enter the channel number.</p> <p>For example, to select channel #20, press 0, 2, 0, or 2, 0, [Enter].</p> <p>Note: While the [Receiver] button is flashing, you cannot select another input source with the remote controller.</p>

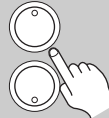

Selecting Channels on the AV controller:

<p>1</p> <p>AV controller Tuning Mode</p> 	<p>Press the [Tuning Mode] button repeatedly to select Channel Search mode or Category Search mode.</p>
<p>2</p> <p>AV controller Enter</p> 	<p>Press [Enter] repeatedly to select a category.</p>
<p>3</p> <p>AV controller Tuning ↑</p> 	<p>Use the Tuning Up and Down [▲]/[▼] buttons to select a channel.</p> <p>In Channel Search mode, you can select any channel.</p> <p>In Category Search mode, you can only select channels from the currently selected category.</p>

Selecting the Previous Channel:

<p>AV controller Return</p>  <p>Remote controller Return</p> 	<p>To listen to the previously selected XM channel, press the [Return] button.</p>
--	--

Displaying XM Radio Information

<p>AV controller</p> <p>Display</p>  <p>Remote controller</p> 	<p>Press the [Display] button repeatedly to cycle through the available information.</p>
--	---

The following information can be displayed:

Channel name



Channel number & preset number



Category



Artist



Song title



Listening mode

Notes:

- If the category, artist, or song title is not available, “- - -” will be displayed instead.
- The listening mode is not displayed when Zone 2 or Zone 3 is selected.

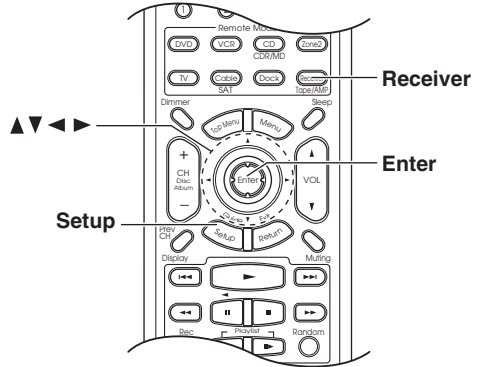

Positioning the XM Mini-Tuner System

You can check the signal strength of the XM radio signal and adjust the position of the XM Mini-Tuner system accordingly.

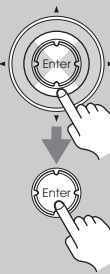
<p>1</p> 	<p>Press the [Receiver] Remote Mode button, followed by the [Setup] button.</p> <p>The main menu appears onscreen.</p>
<p>2</p> 	<p>Use the Up and Down [▲]/[▼] buttons to select “4. Source Setup”, and then press [Enter].</p> <p>The “Source Setup” menu appears.</p> <div style="border: 1px solid black; padding: 5px; margin: 10px 0;"> <p style="text-align: right;">Integra</p> <p>4. Source Setup DVD</p> <p>1. IntelliVolume</p> <p>2. A/V Sync</p> <p>3. Name Edit</p> <p>4. Picture Adjust</p> <p>5. Satellite Radio</p> <p>6. SIRIUS Parental Lock</p> <p style="font-size: small;">▲▼ MOVE ENTER RETURN EXIT</p> </div> <p>Note:</p> <p>If the “Satellite Radio” mode is set to “None” (see page 75), the “5. Satellite Radio” item is not available.</p>

3



Use the Up and Down [▲]/[▼] buttons to select “5. Satellite Radio”, and then press [Enter].

The “Satellite Radio” screen appears. The name of the currently selected input selector is displayed in a box.

4

Position the XM Mini-Tuner Antenna so that as many bars as possible (up to 3) appear on the XM Satellite signal strength meter.

The best signal is achieved when the antenna is pointing to the southern sky through an unobstructed window.

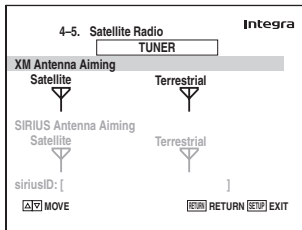

If you cannot receive a satellite signal, position the XM Mini-Tuner System so that as many bars as possible (up to 3) appear on the XM Terrestrial signal strength meter.

Notes:

- So long as the signal strength is good, you can enjoy XM Radio by using either satellite or terrestrial reception.
- Terrestrial signals are only available in certain areas.
- The XM information is only displayed when the “Satellite Radio” mode is set to “XM” or “XM/SIRIUS” (see page 75).
- If you’re using both XM Satellite Radio and SIRIUS Satellite Radio and the “Satellite Radio” mode is set to “XM/SIRIUS” (see page 75), signal strength meters for both systems appear on the same screen.

XM Radio Messages

The following messages may appear while using XM Satellite radio.

❑ CHECK ANTENNA

The XM antenna is not properly connected to the Mini-Tuner Dock. Check the connection. Check the antenna cable for damage.

❑ UPDATING

XM is updating your Mini-Tuner with the latest encryption code. Wait a few seconds until the update is done. Alternatively, you may be attempting to tune to a channel that is blocked or that you cannot receive with your subscription package. To receive that channel, contact XM Satellite Radio.

❑ NO SIGNAL

The XM Mini-Tuner cannot receive the satellite signal. Check the XM antenna for obstructions to the southern sky. Check the antenna positioning with the Antenna Aiming function (see page 78).

❑ LOADING

The AV controller is tuning or decoding audio or text data. Please wait. If this occurs often, check the XM antenna position with the Antenna Aiming function (see page 78).

❑ OFF AIR

The XM channel you selected is not currently broadcasting. Select another channel.

❑ UPGRADE XM TUNER

The connected XM CNP-1000 is incompatible. The AV controller features advanced technology that is designed for use with the XM Mini-Tuner. Contact XM Listener Care and ask about upgrading your XM CNP-1000 to an XM Mini-Tuner. Have the AV controller’s model name and CNP-1000 XM ID number ready beforehand, and explain that your AV controller is displaying the message “Upgrade XM Tuner”. If you already have an XM Mini-Tuner connected and you see this message, turn off the AV controller, make sure the XM Mini-Tuner is properly seated in the Mini-Tuner Dock, and then turn the AV controller back on again. If the message reappears, contact XM Listener Care and explain the issue that you’re experiencing and the corrective actions you’ve tried.

❑ CHECK XM TUNER

The AV controller is having difficulty communicating with the XM Mini-Tuner module. Make sure the XM Mini-Tuner is properly seated in the Mini-Tuner Dock. And make sure the Mini-Tuner Dock cable is properly connected to the AV controller and is not damaged. If the issue persists, contact XM Listener Care. Have the AV controller’s model name ready beforehand, and explain the issue that you’re experiencing and the corrective actions you’ve tried.

❑ Unavailable Channel

You may be attempting to select a channel that is unavailable or has changed to a different channel number. Check xmradio.com for the latest channel listing.

XM Listener Care phone number:	
US:	1-800-967-2346
Canada:	1-877-438-9677

Listening to SIRIUS Satellite Radio® (North American Models Only)

Important SIRIUS Satellite Radio Information

SIRIUS is available in the US for subscribers with addresses in the continental US and is available in Canada for subscribers with a Canadian address. To Get SIRIUS Satellite Radio a subscription and compatible tuner and antenna are required and sold separately. Visit sirius.com for the most complete and up-to-date channel lineup and information. “SIRIUS” and the SIRIUS dog logo and related marks are trademarks of SIRIUS Satellite Radio Inc.

Note:

Hardware and required basic monthly subscription sold separately. Installation costs and other fees and taxes, including a one-time activation fee may apply. Subscription fee is consumer only. All fees and programming subject to change.

What is SIRIUS Satellite Radio?

Simply The Best Radio on Radio™ with all your favorite entertainment including 100% commercial-free music, plus superior sports coverage, uncensored talk and comedy, world-class entertainment, news, weather and more for your car, home or office. For more information visit sirius.com or siriuscanada.ca.

A warning against reverse engineering:

It is prohibited to copy, decompile, disassemble, reverse engineer, or manipulate any technology incorporated in receivers compatible with the SIRIUS Satellite Radio system.

“SIRIUS” and the SIRIUS dog logo are registered trademarks of SIRIUS Satellite Radio Inc.



Setting Up the SiriusConnect™ Home Tuner

The optional SiriusConnect Home tuner kit includes everything for easy home installation, including the SiriusConnect receiver, indoor/outdoor antenna with 21-foot cable, 8-pin mini DIN connector cable, and an AC power adapter. See the SiriusConnect Home tuner's instructions for more information.

Use the 8-pin mini DIN connector cable to connect the SiriusConnect receiver to the SIRIUS jack on the rear of the AV controller.

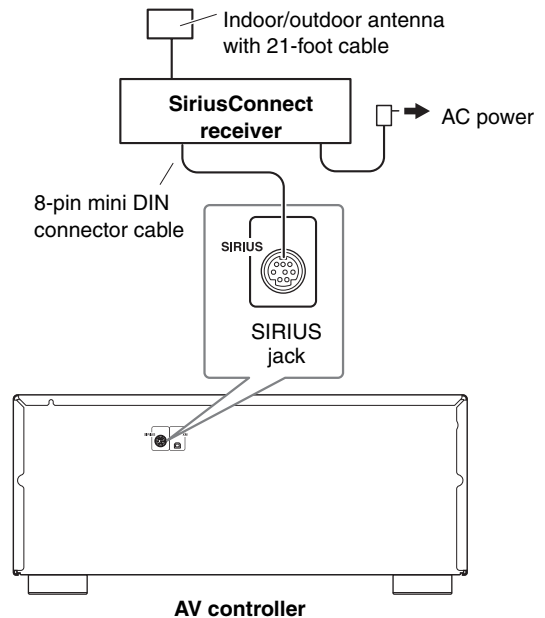

To use the included antenna indoors, you must place it at a north-, west-, or east-facing window, depending on where you live. If this isn't possible, you'll need to install it outside, away from any overhead obstructions.

Listening to the Radio—Continued

Positioning the Antenna

For a consistent satellite signal, the antenna must be positioned correctly. Use the following map to determine which area you are in and position the antenna accordingly.

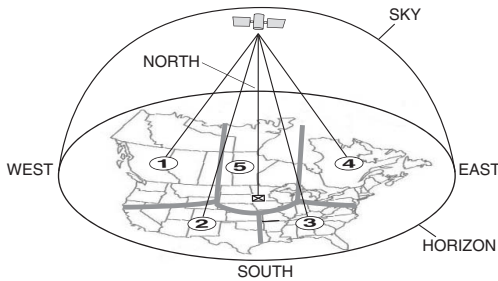

Area 1: Point the antenna toward the sky in the **east, north-east, or southeast**, either through a window or outside.

Area 2: Point the antenna toward the sky in the **north or northeast**, either through a window or outside.

Area 3: Point the antenna toward the sky in the **north or northwest**, either through a window or outside.

Area 4: Point the antenna toward the sky in the **west, north-west, or southwest**, either through a window or outside.

Area 5: Put the antenna outside and point it **straight up**. The antenna cannot be used indoors.

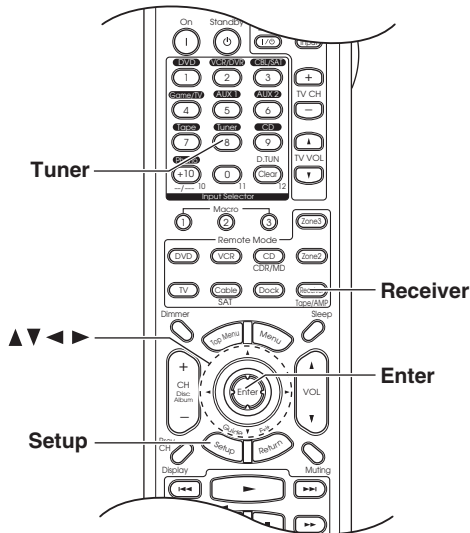

Setting the Satellite Radio Mode

Before you can listen to SIRIUS Satellite Radio, you must set the Satellite Radio mode to SIRIUS.

1

Press the [Receiver] Remote Mode button, followed by the [Setup] button.

The main menu appears onscreen.



2

Use the Up and Down [▲]/[▼] buttons to select “7. Hardware Setup”, and then press [Enter].

The “Hardware Setup” menu appears.

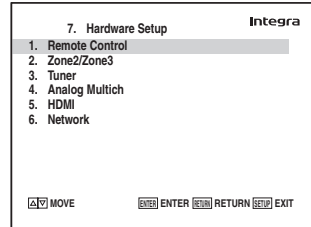

3

Use the Up and Down [▲]/[▼] buttons to select “3. Tuner”, and then press [Enter].

The “Tuner” screen appears.

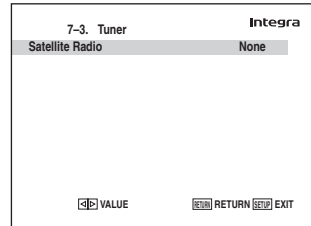

4

Use the Left and Right [◀]/[▶] buttons to select “SIRIUS”.

If there are 2 items on the Tuner screen, use Up and Down [▲]/[▼] buttons to select “Satellite Radio”.

Pressing the Left and Right [◀]/[▶] buttons cycles through the following options: None → XM → SIRIUS → XM/SIRIUS

None: Select if you’re not using satellite radio.

XM: Select to use XM Satellite Radio.

SIRIUS: Select to use SIRIUS Satellite Radio.

XM/SIRIUS: Select to use XM Satellite Radio and SIRIUS Satellite Radio.

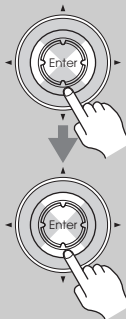

5

When you’ve finished, press the [Setup] button.

Setup closes.



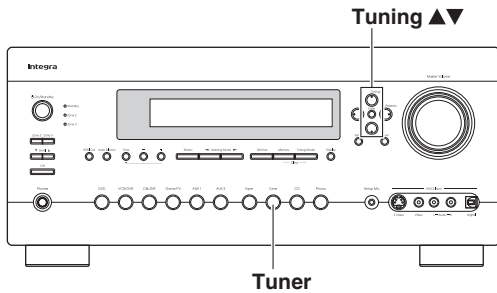

Selecting SIRIUS Satellite Radio

AV controller



On the AV controller, press the [Tuner] Input Selector button repeatedly to select SIRIUS.

Remote controller

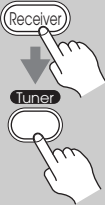

On the remote controller, press the [Receiver] Remote Mode button, and then press the [Tuner] Input Selector button repeatedly to select SIRIUS.

If “CHECK SR TUNER” appears on the display, make sure the SiriusConnect receiver is connected properly. If “ANTENNA ERROR” appears, make sure the antenna is connected properly.

Signing Up for SIRIUS Satellite Radio

Before you can use SIRIUS Satellite Radio, you must first sign up for an account. You’ll need a major credit card and your *SIRIUS Satellite Radio ID*, which you can get from the AV controller, as explained below, or from the SiriusConnect Home tuner package.

1

AV controller

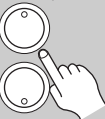

Use the Tuning Up and Down [▲]/[▼] buttons to select channel 0.

Your SIRIUS Satellite Radio ID number is displayed. Write it below.

ID _____

2

To sign up, go to:
<http://activate.siriusradio.com>
 Or call: 1-888-539-SIRIUS (7474)

Selecting SIRIUS Satellite Radio Channels

There are three ways to select SIRIUS Satellite Radio channels:

- Channel Search mode:** select any channel.
- Category Search mode:** select channels by category.
- Direct tuning:** enter channel number.

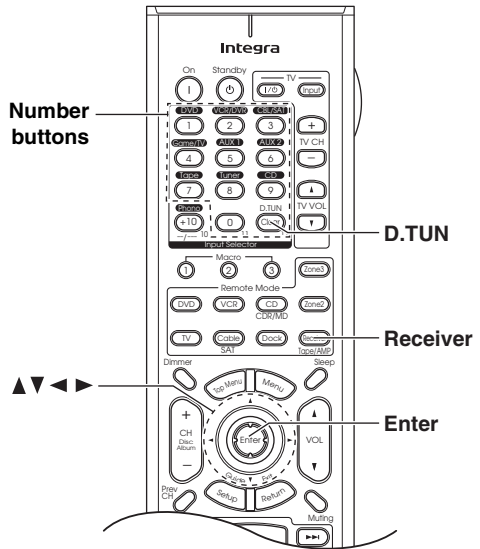

■ Channel Search Mode

1



Press the [Receiver] Remote Mode button, and then press the [Enter] button repeatedly to select Channel Search mode.

ChannelSearch

This procedure can also be performed on the AV controller by using its [Tuner] button, and [Tuning Mode] button.

2



Use the Up and Down [▲]/[▼] buttons to select a channel.

Channel number
 SR 050
 Hot Jams
 Channel name

You can also use the Left and Right [◀]/[▶] buttons to select a category.

Note:

Your ID is also displayed on the Satellite Radio screen. See “Positioning the SiriusConnect Home Antenna” on page 87.

■ Category Search Mode

1

Remote controller



Press the [Receiver] Remote Mode button, and then press the [Enter] button repeatedly to select Category Search mode.

Category Search

This procedure can also be performed on the AV controller by using its [Tuner] button, and [Tuning Mode] button.

2



Use the Left and Right [◀]/[▶] buttons to select a category, and use the Up and Down [▲]/[▼] buttons to select a channel in that category.

■ Direct Tuning

You can select a SIRIUS Satellite Radio channel directly by entering its number.

1

Remote controller



Press the [Receiver] Remote Mode button, followed by the [D.TUN] button. The [Receiver] button flashes.

SR

2



Within 8 seconds, use the number buttons to enter the channel number.

For example, to select channel #20, press 0, 2, 0, or 2, 0, [Enter].

Note:
While the [Receiver] button is flashing, you cannot select another input source with the remote controller.

Notes:

- If you select an unavailable channel, “INVALID CHANNEL” appears on the display.
- If you select a channel that you are not subscribed to, “CALL SIRIUS” appears on the display.
- Channels that are locked must be unlocked before you can listen to them. See “Parental Lock” on page 84 for more information.

Selecting Channels on the AV controller:

1

AV controller
Tuning Mode

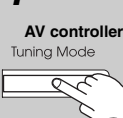

Press the [Tuning Mode] button repeatedly to select Channel Search mode or Category Search mode.

2

AV controller
Enter



Press [Enter] repeatedly to select a category.

3

AV controller
Tuning ↑



Use the Tuning Up and Down [▲]/[▼] buttons to select a channel.

In Channel Search mode, you can select any channel.

In Category Search mode, you can only select channels from the currently selected category.

Selecting the Previous Channel:

AV controller
Return



Remote controller



To listen to the previously selected SIRIUS Satellite Radio channel, press the [Return] button.

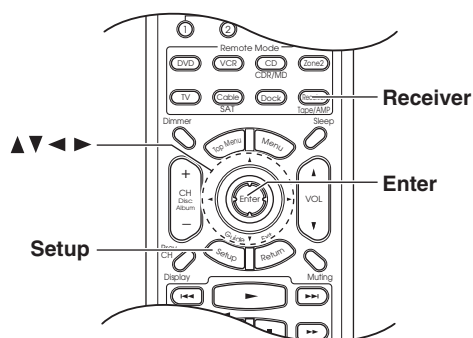

Parental Lock

With SIRIUS Parental Lock, you can lock out channels that you do not want to receive and use a 4-digit PIN number to prevent others from unlocking them.

1 Press the [Receiver] Remote Mode button, followed by the [Setup] button. The main menu appears onscreen.



2 Use the Up and Down [▲]/[▼] buttons to select “4. Source Setup”, and then press [Enter]. The “Source Setup” menu appears.

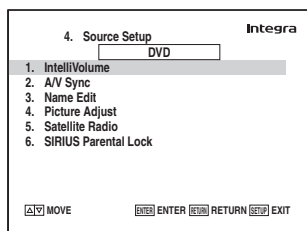
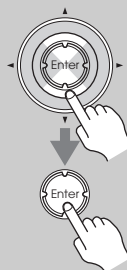

Note:

If the “Satellite Radio” mode is set to “None” or “XM” (see page 81), the “6. SIRIUS Parental Lock” item is not available.

3 Use the Up and Down [▲]/[▼] buttons to select “6. SIRIUS Parental Lock”, and then press [Enter]. The “SIRIUS Parental Lock” screen appears.

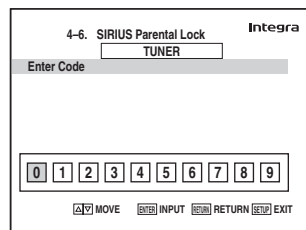

4 Press the [D.TUN] button, and then use the number buttons to enter the 4-digit PIN number.



Or

Use the Left and Right [◀]/[▶] buttons to select a number on the screen, and then press [Enter]. Repeat this for each of the four digits in the PIN number.

If you’re entering the PIN number for the very first time, the PIN is stored, and the following screen appears.

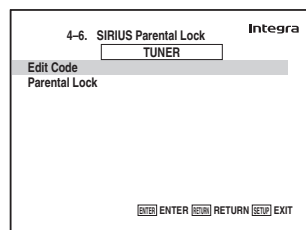

or

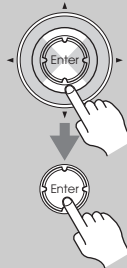

If you’ve already set a PIN number, you must enter the correct PIN to get to this screen. If you enter the wrong PIN, the message “Wrong Code!” appears and you’ll have to enter the PIN again.

5 Use the Up and Down [▲]/[▼] buttons to select “Parental Lock”, and then press [Enter]. The “Parental Lock” screen appears.

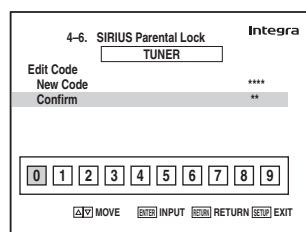
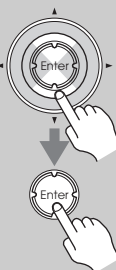

6 Use the Up and Down [▲]/[▼] buttons to select a channel, and use the Left and Right [◀]/[▶] buttons to select Locked or Unlocked.



The number, name, and status of the currently selected channel is displayed.

7 When you've finished, press [Enter] to save your changes, or press [Return] to return to the previous screen without saving.



When [Enter] is pressed, the confirmation message "Locked" or "Unlocked" appears.

8 Press the [Setup] button. Setup closes.



Notes:

- While a channel is locked, it cannot be selected for listening.
- To unlock a channel, you must enter the correct PIN number and change it to Unlocked in step 6.

Changing the PIN Number

1 Press the [Receiver] Remote Mode button, followed by the [Setup] button.



The main menu appears onscreen.

2 Use the Up and Down [▲]/[▼] buttons to select "4. Source Setup", and then press [Enter].

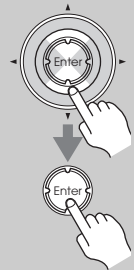

The "Source Setup" menu appears.

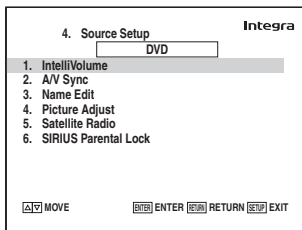

Note:

If the "Satellite Radio" mode is set to "None" or "XM" (see page 81), the "6. SIRIUS Parental Lock" item is not available.

3 Use the Up and Down [▲]/[▼] buttons to select "6. SIRIUS Parental Lock", and then press [Enter]. The "SIRIUS Parental Lock" screen appears.

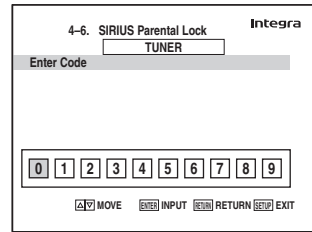
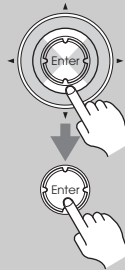

4 Press the [D.TUN] button, and then use the number buttons to enter the old 4-digit PIN number.



Or

Use the Left and Right [◀]/[▶] buttons to select a number on the screen, and then press [Enter]. Repeat this for each of the four digits in the old PIN number.

If you enter the correct PIN number, the following screen appears.

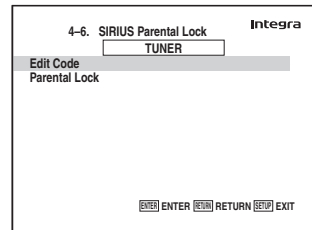

If you enter the wrong PIN number, the message "Wrong Code!" appears and you'll have to enter the PIN again.

5 Use the Up and Down [▲]/[▼] buttons to select "Edit Code", and then press [Enter].

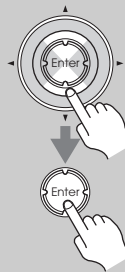

The "New Code" screen appears.

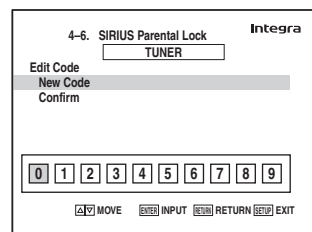

6 Press the [D.TUN] button, and then use the number buttons to enter the new 4-digit PIN number.

Or

Use the Left and Right [◀]/[▶] buttons to select a number on the screen, and then press [Enter]. Repeat this for each of the four digits in the new PIN number. The Confirm screen appears.

The Confirm screen appears.



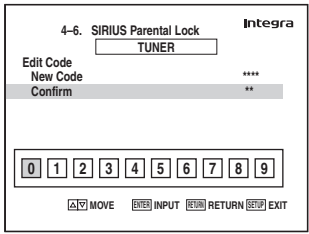

7 Confirm the new PIN number by entering it again.

If you confirm the PIN number correctly, the new PIN is saved and the message “Complete” appears.

If you confirm the PIN number incorrectly, “Wrong Code!” appears, and you’ll be returned to step 5 to try again.

8 Press the [Setup] button. Setup closes.

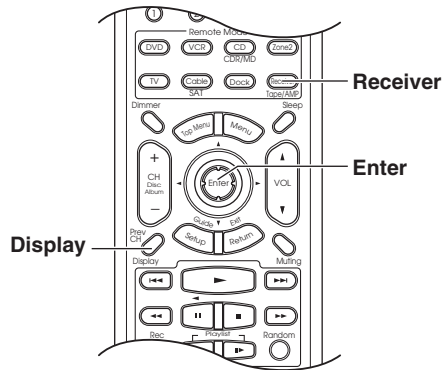



Displaying SIRIUS Satellite Radio Information

Press the [Display] button repeatedly to cycle through the available information.

AV controller
Display

Remote controller
Display



The following information can be displayed:

- Channel name
- ↓
- Channel number & preset number
- ↓
- Category
- ↓
- Artist/composer
- ↓
- Song title
- ↓
- Listening mode

Note:
If the category, artist/composer, or song title is not available, “- - -” will be displayed instead.

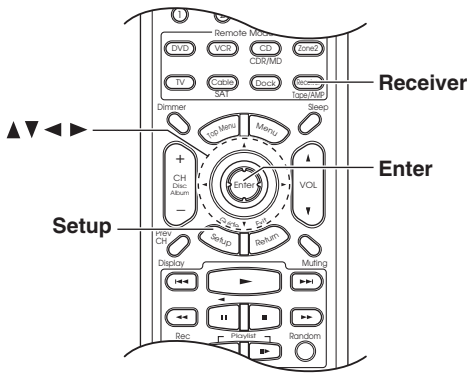

Positioning the SiriusConnect Home Antenna

You can check the strength of the SIRIUS Satellite Radio signal and adjust the position of the SiriusConnect Home antenna accordingly.

1



Press the [Receiver] Remote Mode button, followed by the [Tuner] button, and [Setup] button.

The main menu appears onscreen.

2



Use the Up and Down [▲]/[▼] buttons to select “4. Source Setup”, and then press [Enter].

The “Source Setup” menu appears.

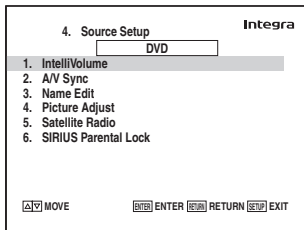

Note:

If the “Satellite Radio” mode is set to “None” (see page 81), the “5. Satellite Radio” item is not available.

3



Use the Up and Down [▲]/[▼] buttons to select “5. Satellite Radio”, and then press [Enter].

The Satellite Radio screen appears. The name of the currently selected input selector is displayed in a box.

4

Position the SiriusConnect Home antenna so that as many bars as possible (up to 3) appear on the SIRIUS Satellite signal strength meter.

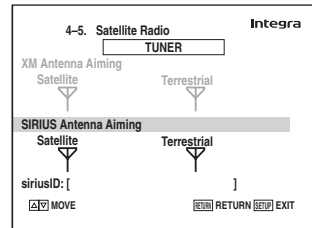

If you cannot receive a satellite signal, position the SiriusConnect Home antenna so that as many bars as possible (up to 3) appear on the SIRIUS Terrestrial signal strength meter.

Notes:

- So long as the signal strength is good, you can enjoy SIRIUS Satellite Radio by using either satellite or terrestrial reception.
- Terrestrial signals are only available in certain areas.
- The SIRIUS information on the Satellite Radio screen is only displayed when the “Satellite Radio” mode is set to “SIRIUS” or “XM/SIRIUS” (see page 81).
- If you’re using both XM Satellite Radio and SIRIUS Satellite Radio and the “Satellite Radio” mode is set to “XM/SIRIUS” (see page 81), signal strength meters for both systems appear on the same screen.

SIRIUS Satellite Radio Messages

The following messages may appear while using SIRIUS Satellite Radio.

❑ **ACQUIRING**

The SiriusConnect receiver is acquiring the signal or no signal is present. Make sure the SiriusConnect Home tuner is connected properly and that there are no obstacles close by.

❑ **ANTENNA ERROR**

Make sure the SiriusConnect Home tuner is connected properly.

❑ **SUB UPDATED**

Displayed while your subscription is being updated. No operations can be performed until this message has cleared.

❑ **UPDATING XXX %**

Displayed while the channel map is being updated. Wait until the updating is complete.

❑ **UPDATING**

Displayed while the SiriusConnect receiver's firmware is being updated.

❑ **INVALID CHANNEL**

Displayed if you select an unavailable channel.

❑ **CALL SIRIUS**

Displayed when you select a channel to which you are not subscribed. Call SIRIUS if you want to subscribe.

❑ **CHECK SR TUNER**

Displayed if the SiriusConnect receiver is not connected. Make sure the SiriusConnect receiver is connected properly, and make sure its AC adapter is plugged in.

Recording

This section explains how to record the input source and how to record audio and video from separate sources.

Notes:

- The surround sound and DSP listening modes cannot be recorded.
- Copy-protected DVDs cannot be recorded.
- Sources connected to the analog multichannel input cannot be recorded.
- Various restrictions apply to digital recording. Refer to the manuals supplied with your digital recording equipment for more details.
- Digital input signals are output by only the digital outputs, and analog input signals are output by only the analog outputs. There is no internal conversion from digital to analog or vice versa.
- DTS signals will be recorded as noise, so don't attempt analog recording of DTS CDs or LDs.

Recording the Input Source

Audio sources can be recorded to a recorder (e.g., cassette deck, CDR, MD) connected to the TAPE OUT or DIGITAL OPTICAL OUT jacks. Video sources can be recorded to a video recorder (e.g., VCR, DVR) connected to the VCR/DVR OUT jacks. See pages 28 to 44 for hookup information.

1



Remote controller



Use the input selector buttons to select the source that you want to record.

See “Which Connections Should I Use?” on page 29 to see which signals can be output and recorded.

You can watch the source while recording it. The AV controller's Master Volume control has no effect on recording.

2

On your recorder, start recording.

3

On the source component, start playback.

Note:

If you select a different input source during recording, that input source will be recorded instead.

Recording from Different AV Sources

You can overdub audio onto your video recordings by simultaneously recording audio and video from two separate sources. This is possible because only the audio source is switched when an audio-only input source, such as TAPE, Tuner, or CD, is selected, the video source remains the same.

In the following example, audio from the CD player connected to the CD IN and video from the camcorder connected to the AUX 2 INPUT VIDEO jack are recorded by the VCR connected to the VCR/DVR OUT jacks.

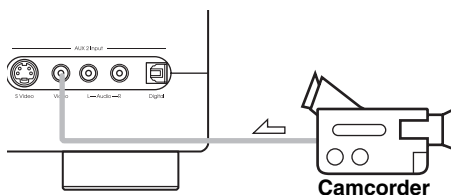

↗ : video signal
↘ : audio signal

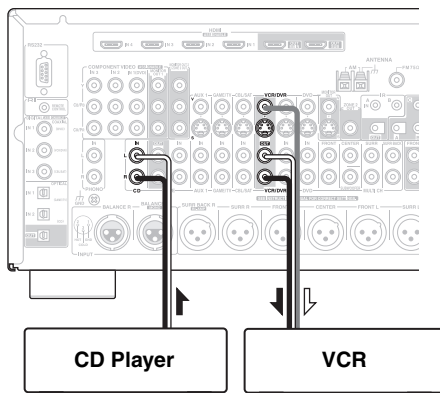

- 1** Prepare the camcorder and CD player for playback.
- 2** Prepare the VCR for recording.
- 3** Press the [AUX 2] input selector button.
- 4** Press the [CD] input selector button.
This selects the CD player as the audio source but leaves the camcorder as the video source.
- 5** Start recording on the VCR, then start playback on the camcorder and CD player.
Video from the camcorder and audio from the CD player are recorded by the VCR.

Using the Listening Modes

Selecting the Listening Modes

For a description of each listening mode, see “About the Listening Modes” on page 97.

- The Dolby Digital and DTS listening modes can only be selected if your DVD player is connected to the AV controller with a digital audio connection (coaxial, optical, or HDMI).
- The listening modes you can select depends on the format of the input signal. To check the format, see “Displaying Source Information” on page 66.
- While a pair of headphones is connected, you can only select the Mono, Direct, or Stereo listening mode.

Selecting on the AV Controller

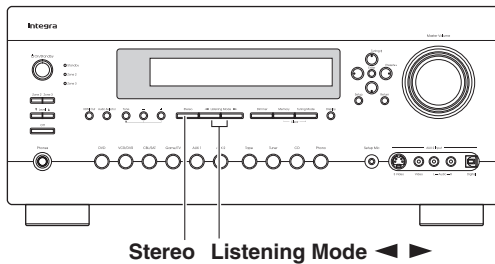

- **[Stereo] button**
This button selects the Stereo listening mode.
- **Listening Mode [◀]/[▶] buttons**
Pressing these buttons repeatedly cycles through all of the listening modes that can be used with the current input source.

Selecting with the Remote Controller

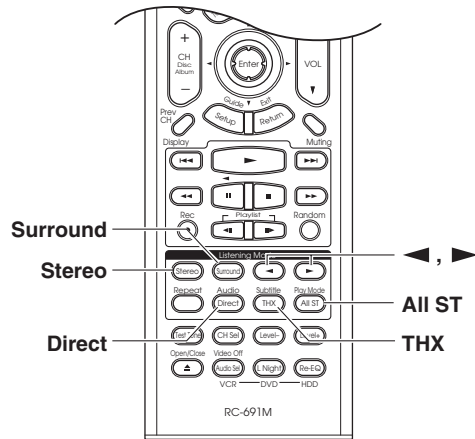

- **[Stereo] button**
This button selects the Stereo listening mode.
- **[Surround] button**
This button selects the Dolby Digital and DTS listening modes.
- **Listening Mode [◀]/[▶] buttons**
Pressing these buttons repeatedly cycles through all of the listening modes that can be used with the current input source.
- **[Direct] button**
This button selects the Direct listening mode.
- **[THX] button**
This button selects the THX listening modes.
- **[All ST] button**
This button selects the All Channel Stereo listening mode.

Using the Listening Modes—Continued

Listening Modes Available for Each Source Format

Analog and PCM Sources

✓: Available Listening Modes

Source format	Analog/PCM		Multi channel Analog	Multichannel PCM					
	32–96 kHz ^{*1}	176.4/192kHz ^{*2}		32–96 kHz ^{*1}			176.4/192 kHz ^{*2}		
				Multi channel	2ch	Mono/Multiplex	Multi channel	2ch	Mono/Multiplex
Media	CD, TV, radio,		DVD	DVD			DVD		
Listening Mode									
Direct	✓	✓	✓	✓	✓	✓	✓	✓	✓
Stereo	✓	✓		✓	✓	✓	✓	✓	✓
Mono	✓			✓	✓	✓			
Multichannel			✓	✓			✓		
Neo:6				✓ ^{*4}					
Neural THX				✓ ^{*7}	✓ ^{*5*7}				
Dolby PLII Movie/ Dolby PLIIx Movie ^{*3}	✓			✓ ^{*4}	✓				
Dolby PLII Music/ Dolby PLIIx Music ^{*3}	✓			✓ ^{*4}	✓				
Dolby PLII Game/ Dolby PLIIx Game ^{*3}	✓				✓				
Dolby EX				✓ ^{*4}					
Neo:6 Cinema	✓				✓				
Neo:6 Music	✓				✓				
THX Cinema/Music/Games ^{*5}				✓					
Dolby PLII/Dolby PLIIx Movie + THX Cinema ^{*5}	✓ ^{*3}			✓ ^{*4}	✓ ^{*3}				
Dolby PLII/Dolby PLIIx Music + THX Music ^{*5}	✓ ^{*3}			✓ ^{*4}	✓ ^{*3}				
Dolby PLII/Dolby PLIIx Game + THX Games ^{*5}	✓ ^{*3}				✓ ^{*3}				
Neo:6 Cinema/Music +THX Cinema/Music ^{*5}	✓				✓				
Neo:6 + THX Cinema/Music/Game				✓ ^{*4}					
PLII Game + THX Ultra2 Games	✓				✓				
THX Surround EX				✓ ^{*4}					
THX Ultra2 Cinema/Music/Games				✓ ^{*4}					
Neural THX + THX Cinema/Music/Games ^{*5}	✓			✓ ^{*7}	✓ ^{*7}				
MonoMovie ^{*5*6}	✓			✓	✓	✓			
Orchestra ^{*5*6}	✓			✓	✓	✓			
Unplugged ^{*5*6}	✓			✓	✓	✓			
Studio-Mix ^{*5*6}	✓			✓	✓	✓			
TV Logic ^{*5*6}	✓			✓	✓	✓			
AllChStereo	✓			✓	✓	✓			
FullMono	✓			✓	✓	✓			
T-D ^{*6}	✓			✓	✓	✓			

*1. 32/44.1/48/88.2/96kHz

*2. DVD-Audio discs output multichannel 176.4/192 kHz PCM only via HDMI.

*3. If there are no surround back speakers, Dolby Pro Logic II is used.

*4. Cannot be selected with some source formats.

*5. Available only when using surround speakers.

*6. PCM of 88.2kHz and 96kHz are processed at 44.1kHz and 48kHz respectively.

*7. It is possible to select it by the signal of 32-48kHz.

■ : Requires 6.1/7.1 speakers.

■ : Requires 7.1 speakers.

Using the Listening Modes—Continued

Dolby Digital, and Dolby Digital Plus Sources

✓: Available Listening Modes

Source format	Dolby Digital			Dolby Digital Plus		
	Multichannel	2ch	Mono/Multiplex	Multichannel	2ch	Mono/Multiplex
Media	DVD, DTV, etc.			Blu-ray, HD DVD		
Listening Mode						
Direct	✓	✓	✓	✓	✓	✓
Stereo	✓	✓	✓	✓	✓	✓
Mono	✓	✓	✓	✓	✓	✓
Neo:6	✓ ^{*3}			✓ ^{*3}		
Neural THX	✓	✓ ^{*4}		✓	✓ ^{*4}	
DolbyDigital	✓					
DolbyDigital Plus				✓ ^{*1}		
Dolby PLII Movie/ Dolby PLIIx Movie ^{*2}	✓ ^{*3}	✓		✓ ^{*3}	✓	
Dolby PLII Music/ Dolby PLIIx Music ^{*2}	✓ ^{*3}	✓		✓ ^{*3}	✓	
Dolby PLII Game/ Dolby PLIIx Game ^{*2}		✓			✓	
Dolby EX	✓ ^{*3}	✓		✓ ^{*3}		
Neo:6 Cinema		✓			✓	
Neo:6 Music		✓			✓	
THX Cinema/Music/Games ^{*4}	✓			✓		
Dolby PLII/Dolby PLIIx Movie + THX Cinema ^{*4}	✓ ^{*3}	✓ ^{*2}		✓ ^{*3}	✓ ^{*2}	
Dolby PLII/Dolby PLIIx Music + THX Music ^{*4}	✓ ^{*3}	✓ ^{*2}		✓ ^{*3}	✓ ^{*2}	
Dolby PLII/Dolby PLIIx Game + THX Games ^{*4}		✓ ^{*2}			✓ ^{*2}	
Neo:6 Cinema/Music + THX Cinema/Music ^{*4}		✓			✓	
Neo:6 + THX Cinema/Music/Game	✓ ^{*3}			✓ ^{*3}		
PLII Game + THX Ultra2 Games		✓			✓	
THX Surround EX	✓ ^{*3}			✓ ^{*3}		
THX Ultra2 Cinema/Music/Games	✓ ^{*3}			✓ ^{*3}		
Neural THX + THX Cinema/Music/Games ^{*4}	✓	✓		✓	✓	
MonoMovie ^{*4}	✓	✓	✓	✓	✓	✓
Orchestra ^{*4}	✓	✓	✓	✓	✓	✓
Unplugged ^{*4}	✓	✓	✓	✓	✓	✓
Studio-Mix ^{*4}	✓	✓	✓	✓	✓	✓
TV Logic ^{*4}	✓	✓	✓	✓	✓	✓
AllChStereo	✓	✓	✓	✓	✓	✓
FullMono	✓	✓	✓	✓	✓	✓
T-D	✓	✓	✓	✓	✓	✓

*1. If there are no surround back speakers, depending on the input signal, Dolby Digital may be used.

*2. If there are no surround back speakers, Dolby Pro Logic II is used.

*3. Cannot be selected with some source formats.

*4. Available only when using surround speakers.

■ : Requires 6.1/7.1 speakers.

■ : Requires 7.1 speakers.

Note:

With some HD DVD and Blu-ray discs, a noise may be heard during playback. This may occur when the audio format changes during playback. It is not a malfunction.

Using the Listening Modes—Continued

DTS Sources

✓: Available Listening Modes

Source format	DTS, DTS96/24			DTS-ES Discrete/Matrix
	Multichannel	2ch	Mono	
Media	DVD, CD, etc.			DVD, CD, etc.
Listening Mode	DVD, CD, etc.			DVD, CD, etc.
Direct	✓	✓	✓	✓
Stereo	✓	✓	✓	✓
Mono	✓	✓	✓	✓
DTS, DTS 96/24	✓			✓
DTS-ES Discrete/Matrix				✓ ^{*1}
Neo:6	✓ ^{*3}			
Neural THX	✓ ^{*5}	✓ ^{*4*5}		
Dolby PLII Movie/ Dolby PLIIx Movie ^{*2}	✓ ^{*3}	✓		
Dolby PLII Music/ Dolby PLIIx Music ^{*2}	✓ ^{*3}	✓		
Dolby PLII Game/ Dolby PLIIx Game ^{*2}		✓		
Dolby EX	✓ ^{*3}			
Neo:6 Cinema	✓	✓		
Neo:6 Music	✓	✓		
THX Cinema/Music/Games ^{*4}	✓			
DTS-ES Discrete/Matrix ^{*4} + THX Cinema/Music/Games				✓ ^{*1}
Dolby PLII/Dolby PLIIx Movie + THX Cinema/Music ^{*4}	✓ ^{*3}	✓ ^{*2}		
Dolby PLII/Dolby PLIIx Music + THX Music ^{*4}		✓ ^{*2}		
Dolby PLII/Dolby PLIIx Game + THX Games ^{*4}		✓ ^{*2}		
Neo:6 Cinema/Music + THX Cinema/Music ^{*4}		✓		
Neo:6 + THX Cinema/Music/Game	✓ ^{*3}			
PLII Game + THX Ultra2 Games		✓		
THX Surround EX	✓ ^{*3}			
THX Ultra2 Cinema/Music/Games	✓ ^{*3}			
Neural THX + THX Cinema/Music/Games ^{*4}	✓ ^{*5}	✓ ^{*5}		
MonoMovie ^{*4*5}	✓	✓	✓	✓
Orchestra ^{*4*5}	✓	✓	✓	✓
Unplugged ^{*4*5}	✓	✓	✓	✓
Studio-Mix ^{*4*5}	✓	✓	✓	✓
TV Logic ^{*4*5}	✓	✓	✓	✓
AllChStereo	✓	✓	✓	✓
FullMono	✓	✓	✓	✓
T-D ^{*5}	✓	✓	✓	✓

*1. If there are no surround back speakers, DTS is used.

*2. If there are no surround back speakers, Dolby Pro Logic II is used.

*3. Cannot be selected with some source formats.

*4. Available only when using surround speakers.

*5. DTS 96/24 is processed as DTS.

■ : Requires 6.1/7.1 speakers.

■ : Requires 7.1 speakers.

Using the Listening Modes—Continued

TrueHD Sources

✓: Available Listening Modes

Source format	TrueHD			TrueHD 192kHz		
	Multichannel	2ch	Mono/Multiplex	Multichannel	2ch	Mono/Multiplex
Media	Blu-ray, HD DVD			Blu-ray, HD DVD		
Listening Mode	Blu-ray, HD DVD			Blu-ray, HD DVD		
Direct	✓	✓	✓	✓	✓	
Stereo	✓	✓	✓	✓	✓	
Mono	✓	✓	✓			
TrueHD	✓			✓		
Neo:6	✓ ^{*2}					
Neural THX	✓ ^{*4}	✓ ^{*3*4}				
Dolby PLII Movie/ Dolby PLIIx Movie ^{*1}	✓ ^{*2}	✓				
Dolby PLII Music/ Dolby PLIIx Music ^{*1}	✓ ^{*2}	✓				
Dolby PLII Game/ Dolby PLIIx Game ^{*1}		✓				
Dolby EX	✓ ^{*2}					
Neo:6 Cinema		✓				
Neo:6 Music		✓				
THX Cinema/Music/Games ^{*3}	✓					
Dolby PLII/Dolby PLIIx Movie + THX Cinema ^{*3}	✓ ^{*2}	✓ ^{*1}				
Dolby PLII/Dolby PLIIx Music + THX Music ^{*3}	✓ ^{*2}	✓ ^{*1}				
Dolby PLII/Dolby PLIIx Game + THX Games ^{*3}		✓ ^{*1}				
Neo:6 Cinema/Music + THX Cinema/Music ^{*3}		✓				
Neo:6 + THX Cinema/Music/Game	✓ ^{*2}					
PLII Game + THX Ultra2 Cinema		✓				
THX Surround EX	✓ ^{*2}					
THX Ultra2 Cinema/Music/Games	✓ ^{*2}					
Neural THX + THX Cinema/Music/Games ^{*3}	✓ ^{*4}	✓ ^{*4}				
MonoMovie ^{*3}	✓	✓	✓			
Orchestra ^{*3}	✓	✓	✓			
Unplugged ^{*3}	✓	✓	✓			
Studio-Mix ^{*3}	✓	✓	✓			
TV Logic ^{*3}	✓	✓	✓			
AllChStereo	✓	✓	✓			
FullMono	✓	✓	✓			
T-D	✓	✓	✓			

*1. If there are no surround back speakers, Dolby Pro Logic II is used.

*2. Cannot be selected with some source formats.

*3. Available only when using surround speakers.

*4. It is possible to select it by the signal of 32-48kHz.

■ : Requires 6.1/7.1 speakers.

■ : Requires 7.1 speakers.

Note:

With some HD DVD and Blu-ray discs, a noise may be heard during playback. This may occur when the audio format changes during playback. It is not a malfunction.

Using the Listening Modes—Continued

DTS-HD Sources

✓: Available Listening Modes

Source format	DTS-HD High Resolution			DTS-HD Master Audio			DTS-HD Master Audio 192kHz		
	Multi channel	2ch	Mono	Multi channel	2ch	Mono	Multi channel	2ch	Mono
Media	Blu-ray, HD DVD			Blu-ray, HD DVD			Blu-ray, HD DVD		
Listening Mode	Blu-ray, HD DVD			Blu-ray, HD DVD			Blu-ray, HD DVD		
Direct	✓	✓	✓	✓	✓	✓	✓	✓	
Stereo	✓	✓	✓	✓	✓	✓	✓	✓	
Mono	✓	✓	✓	✓	✓	✓			
DTS-HD High Resolution	✓								
DTS-HD Master Audio				✓			✓		
Neo:6	✓ ^{*2}			✓ ^{*2}					
Neural THX	✓ ^{*4}	✓ ^{*3*4}		✓ ^{*4}	✓ ^{*3*4}				
Dolby PLII Movie/ Dolby PLIIx Movie ^{*1}	✓ ^{*2}	✓		✓ ^{*2}	✓				
Dolby PLII Music/ Dolby PLIIx Music ^{*1}	✓ ^{*2}	✓		✓ ^{*2}	✓				
Dolby PLII Game/ Dolby PLIIx Game ^{*1}		✓			✓				
Dolby EX	✓ ^{*2}			✓ ^{*2}					
Neo:6 Cinema		✓			✓				
Neo:6 Music		✓			✓				
THX Cinema/Music/Games ^{*3}	✓			✓					
Dolby PLII/Dolby PLIIx Movie + THX Cinema ^{*3}	✓ ^{*2}	✓ ^{*1}		✓ ^{*2}	✓ ^{*1}				
Dolby PLII/Dolby PLIIx Music + THX Music ^{*3}	✓ ^{*2}	✓ ^{*1}		✓ ^{*2}	✓ ^{*1}				
Dolby PLII/Dolby PLIIx Game + THX Games ^{*3}		✓ ^{*1}			✓ ^{*1}				
Neo:6 Cinema/Music + THX Cinema/Music ^{*3}		✓			✓				
Neo:6 + THX Cinema/Music/Game	✓ ^{*2}			✓ ^{*2}					
PLII Game + THX Ultra2 Games		✓			✓				
THX Surround EX	✓ ^{*2}			✓ ^{*2}					
THX Ultra2 Cinema/Music/Games	✓ ^{*2}			✓ ^{*2}					
Neural THX + THX Cinema/Music/Games ^{*3}	✓ ^{*4}	✓ ^{*4}		✓ ^{*4}	✓ ^{*4}				
MonoMovie ^{*3}	✓	✓	✓	✓	✓	✓			
Orchestra ^{*3}	✓	✓	✓	✓	✓	✓			
Unplugged ^{*3}	✓	✓	✓	✓	✓	✓			
Studio-Mix ^{*3}	✓	✓	✓	✓	✓	✓			
TV Logic ^{*3}	✓	✓	✓	✓	✓	✓			
AllChStereo	✓	✓	✓	✓	✓	✓			
FullMono	✓	✓	✓	✓	✓	✓			
T-D	✓	✓	✓	✓	✓	✓			

*1. If there are no surround back speakers, Dolby Pro Logic II is used.

*2. Cannot be selected with some source formats.

*3. Available only when using surround speakers.

*4. It is possible to select it by the signal of 32-48kHz.

■ : Requires 6.1/7.1 speakers.

■ : Requires 7.1 speakers.

Note:

With some HD DVD and Blu-ray discs, a noise may be heard during playback. This may occur when the audio format changes during playback. It is not a malfunction.

Using the Listening Modes—Continued

DTS Express and DSD Sources

✓: Available Listening Modes

Source format	DTS Express			DSD ^{*1}	
	Multichannel	2ch	Mono	Multichannel (3/2.1)	2ch
Media	Blu-ray, HD DVD			SACD	
Listening Mode					
Direct	✓	✓	✓	✓	✓
Stereo	✓	✓	✓	✓	✓
Mono	✓	✓	✓	✓	✓
DTS Express	✓				
DSD				✓	
Neo:6	✓ ^{*3}			✓	
Neural THX	✓	✓ ^{*4}		✓	✓ ^{*4}
Dolby PLII Movie/ Dolby PLIIx Movie ^{*2}	✓ ^{*3}	✓		✓	✓
Dolby PLII Music/ Dolby PLIIx Music ^{*2}	✓ ^{*3}	✓		✓	✓
Dolby PLII Game/ Dolby PLIIx Game ^{*2}		✓			✓
Dolby EX	✓ ^{*3}			✓	
Neo:6 Cinema		✓			✓
Neo:6 Music		✓			✓
THX Cinema/Music/Games ^{*4}	✓			✓	
Dolby PLII/Dolby PLIIx Movie + THX Cinema ^{*4}	✓ ^{*3}	✓ ^{*2}		✓	✓ ^{*2}
Dolby PLII/Dolby PLIIx Music + THX Music ^{*4}	✓ ^{*3}	✓ ^{*2}		✓	✓ ^{*2}
Dolby PLII/Dolby PLIIx Game + THX Games ^{*4}		✓ ^{*2}			✓ ^{*2}
Neo:6 Cinema/Music + THX Cinema/Music ^{*4}		✓			✓
Neo:6 + THX Cinema/Music/Game	✓ ^{*3}			✓	
PLII Game + THX Ultra2 Games		✓			✓
THX Surround EX	✓ ^{*3}			✓	
THX Ultra2 Cinema/Music/Games	✓ ^{*3}			✓	
Neural THX + THX Cinema/Music/Games ^{*4}	✓	✓		✓	✓
MonoMovie ^{*4}	✓	✓	✓	✓	✓
Orchestra ^{*4}	✓	✓	✓	✓	✓
Unplugged ^{*4}	✓	✓	✓	✓	✓
Studio-Mix ^{*4}	✓	✓	✓	✓	✓
TV Logic ^{*4}	✓	✓	✓	✓	✓
AllChStereo	✓	✓	✓	✓	✓
FullMono	✓	✓	✓	✓	✓
T-D	✓	✓	✓	✓	✓

*1. DSD sources are converted and handled as PCM.

*2. If there are no surround back speakers, Dolby Pro Logic II is used.

*3. Cannot be selected with some source formats.

*4. Available only when using surround speakers.

■ : Requires 6.1/7.1 speakers.

■ : Requires 7.1 speakers.



If you can select PCM or DSD output on your SACD player, in some cases, selecting PCM will provide the best sound quality.

Note:

With some HD DVD and Blu-ray discs, a noise may be heard during playback. This may occur when the audio format changes during playback. It is not a malfunction.

About the Listening Modes

The AV controller's listening modes can transform your listening room into a movie theater or concert hall, with high fidelity and stunning surround sound.

The Listening Mode button illustration shows that listening modes can be selected.

The Listening Mode button illustration shows the remote controller buttons.

See "Selecting the Listening Modes" on page 90 for information on the use of the Listening Mode buttons.

Direct

Button: 

In this mode, audio from the input source is output directly with minimal processing, providing high-fidelity reproduction. All of the source's audio channels are output as they are.

Stereo

Button: 

Sound is output by the front left and right speakers and subwoofer.

Mono

Use this mode when watching an old movie with a mono soundtrack, or use it with the foreign language soundtracks recorded in the left and right channels of some movies. It can also be used with DVDs or other sources containing multiplexed audio, such as karaoke DVDs.

Multichannel

This mode is for use with analog or PCM multichannel sources.

Dolby Pro Logic IIx

Dolby Pro Logic II

Dolby Pro Logic IIx expands any 2-channel source for 7.1-channel playback. It provides a very natural and seamless surround-sound experience that fully envelops the listener. As well as music and movies, video games can also benefit from the dramatic spatial effects and vivid imaging. If you're not using any surround back speakers, **Dolby Pro Logic II** will be used instead of Dolby Pro Logic IIx.

- **Dolby PLIIx Movie**

Use this mode with any stereo or Dolby Surround (Pro Logic) movie (e.g., TV, DVD, VHS).

- **Dolby PLIIx Music**

Use this mode with any stereo or Dolby Surround (Pro Logic) music source (e.g., CD, radio, cassette, TV, VHS, DVD).

- **Dolby PLIIx Game**

Use this mode with video games, especially those that bear the Dolby Pro Logic II logo.

Dolby Digital

Use this mode with DVDs that bear the Dolby Digital logo, and Dolby Digital TV broadcasts. This is the most common digital surround-sound format, and it'll put you right in the middle of the action, just like being in a movie theater or concert hall.

5.1-channel source + Dolby EX

These modes expand 5.1-channel sources for 6.1/7.1-channel playback. They're especially suited to Dolby EX soundtracks that include a matrix-encoded surround back channel. The additional channel adds an extra dimension and provides an enveloping surround sound experience, perfect for rotating and fly-by sound effects.

Dolby Digital Plus

Developed for use with HDTV, including the new video disc formats Blu-ray and HD DVD, this is the latest multichannel audio format from Dolby. It supports up to 7.1 channels with 48 kHz sampling rate.

Dolby TrueHD

Designed to take full advantage of the additional storage space offered by the new Blu-ray and HD DVD disc formats, this new Dolby format offers up to 7.1 discrete channels of digital audio with 48/96 kHz, up to 5.1-channels with 192 kHz sampling rate.

For the signals supported by the AV controller, see page 94.

5.1-channel source + Dolby PLIIx Music

These modes use the Dolby Pro Logic IIx Music mode to expand 5.1-channel sources for 6.1/7.1-channel playback.

5.1-channel source + Dolby PLIIx Movie

These modes use the Dolby Pro Logic IIx Movie mode to expand 5.1-channel sources for 7.1-channel playback.

DTS

The DTS digital surround-sound format supports up to 5.1 discrete channels and uses less compression for high-fidelity reproduction. Use it with DVDs and CDs that bear the DTS logo.

DTS 96/24

This mode is for use with DTS 96/24 sources. This is high-resolution DTS with a 96 kHz sampling rate and 24-bit resolution, providing superior fidelity. Use it with DVDs that bear the DTS 96/24 logo.

DTS-ES Discrete

This mode is for use with DTS-ES Discrete soundtracks, which use a discrete surround back channel for true 6.1/7.1-channel playback. The seven totally separate audio channels provide better spatial imaging and 360-degree sound localization, perfect for sounds that pan across the surround channels. Use it with DVDs that bear the DTS-ES logo, especially those with a DTS-ES Discrete soundtrack.

DTS-ES Matrix

This mode is for use with DTS-ES Matrix soundtracks, which use a matrix-encoded back-channel for 6.1/7.1-channel playback. Use it with DVDs that bear the DTS-ES logo, especially those with a DTS-ES Matrix soundtrack.

DTS Neo:6

This mode expands any 2-channel source for up to 7.1-channel playback. It uses seven full-bandwidth channels of matrix decoding for matrix-encoded material, providing a very natural and seamless surround sound experience that fully envelops the listener.

- **Neo:6 Cinema**

Use this mode with any stereo movie (e.g., TV, DVD, VHS).

- **Neo:6 Music**

Use this mode with any stereo music source (e.g., CD, radio, cassette, TV, VHS, DVD).

5.1-channel source + Neo:6

This mode uses Neo:6 to expand 5.1-channel sources for 6.1/7.1-channel playback.

DTS-HD High Resolution Audio

Developed for use with HDTV, including the new video disc formats Blu-ray and HD DVD, this is the latest multichannel audio format from DTS. It supports up to 7.1 channels with 96 kHz sampling rate.

DTS-HD Master Audio

Designed to take full advantage of the additional storage space offered by the new Blu-ray and HD DVD disc formats, this new DTS format offers up to 7.1 discrete channels of digital audio with 48/96 kHz, up to 5.1-channels with 192 kHz sampling rate.

For the signals supported by the AV controller, see page 95.

DTS Express

This format supports up to 5.1 channels and a lower sampling rate of 48 kHz. Applications include interactive audio and commentary encoding for HD DVD Sub Audio and Blu-ray Secondary Audio. Also broadcast and media servers.

Neural THX 5.1/7.1

Neural-THX Surround employs psychoacoustic frequency domain processing, which allows delivery of a more detailed sound stage, with superior channel separation and localization of audio elements. The Neural THX 5.1 and Neural THX 7.1 modes can expand any 2-channel stereo source for 5.1- or 7.1-channel playback, respectively. Use them with CD, radio, cassette, TV, VHS, DVD, and other 2-channel stereo sources, including video games. Neural-THX Surround can also be used by broadcasters to encode and transmit surround-sound content over a stereo signal, which listeners can enjoy as either surround sound or normal stereo. XM Satellite Radio, for example, is using Neural-THX Surround on select channels, which the AV controller can expand from 5.1 channels to 7.1 channels.

DSD

DSD stands for *Direct Stream Digital* and is the format used to store digital audio on Super Audio CDs (SACD). This mode can be used with SACDs that feature multi-channel audio.

THX

Founded by George Lucas, THX develops stringent standards that ensure movies are reproduced in movie theaters and home theaters just as the director intended. THX Modes carefully optimize the tonal and spatial characteristics of the soundtrack for reproduction in the home-theater environment. They can be used with 2-channel matrixed and multichannel sources.

Surround back speaker output depends on the source material and the selected listening mode.

- **THX Cinema**

THX Cinema mode corrects theatrical soundtracks for playback in a home theater environment. In this mode, THX Loudness Plus is configured for cinema levels and Re-EQ, Timbre Matching, and Adaptive Decorrelation are active.

- **THX Music**

THX Music mode is tailored for listening to music, which is typically mastered at significantly higher levels than movies. In this mode, THX Loudness Plus is configured for music playback and only Timbre Matching is active.

- **THX Games**

THX Games mode is meant for spatially accurate playback of game audio, which is often mixed similarly to movies but in a smaller environment. THX Loudness Plus is configured for game audio levels, with Timbre Matching active.

- **THX Ultra2 Cinema**

This mode expands 5.1-channel sources for 7.1-channel playback. It does this by analyzing the composition of the surround source, optimizing the ambient and directional sounds to produce the surround back channel output.

- **THX Ultra2 Music**

This mode is designed for use with music. It expands 5.1-channel sources for 7.1-channel playback.

- **THX Ultra2 Games**

This mode is designed for use with video games. It can expand 5.1-channel sources for 6.1/7.1-channel playback.

- **THX Surround EX**

This mode expands 5.1-channel sources for 6.1/7.1-channel playback. It's especially suited to Dolby Digital EX sources. THX Surround EX, also known as Dolby Digital Surround EX, is a joint development between Dolby Laboratories and THX Ltd.

Onkyo Original DSP Modes

Mono Movie

This mode is suitable for old movies and other mono sources. The center speaker outputs the sound as it is, while reverb is applied to the sound output by the other speakers, giving presence to even mono material.

Orchestra

Suitable for classical or operatic music, this mode emphasizes the surround channels in order to widen the stereo image, and simulates the natural reverberation of a large hall.

Unplugged

Suitable for acoustic instruments, vocals, and jazz, this mode emphasizes the front stereo image, giving the impression of being right in front of the stage.

Studio-Mix

Suitable for rock or pop music, listening to music in this mode creates a lively sound field with a powerful acoustic image, like being at a club or rock concert.

TV Logic

This mode adds realistic acoustics to TV shows produced in a TV studio, surround effects to the entire sound, and clarity to voices.

All Ch Stereo

Ideal for background music, this mode fills the entire listening area with stereo sound from the front, surround, and surround back speakers.

Full Mono

In this mode, all speakers output the same sound in mono, so the sound you hear is the same regardless of where you are within the listening room.

T-D (Theater-Dimensional)

With this mode you can enjoy a virtual 5.1 surround sound even with only two or three speakers. This works by controlling how sounds reach the listener's left and right ears. Good results may not be possible if there's too much reverb, so we recommend that you use this mode in an environment with little or no natural reverb.

Advanced Setup

The onscreen setup menus appear on the connected TV and provide a convenient way to change the AV controller's various settings. Settings are organized into eight categories on the **main menu**, most containing a **submenu**.

The onscreen menus shown in this manual may be slightly different from what you see on your TV.

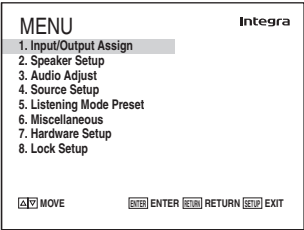

Menu Map

The following map shows how the setup menus are organized. Use the page numbers to locate information about items.

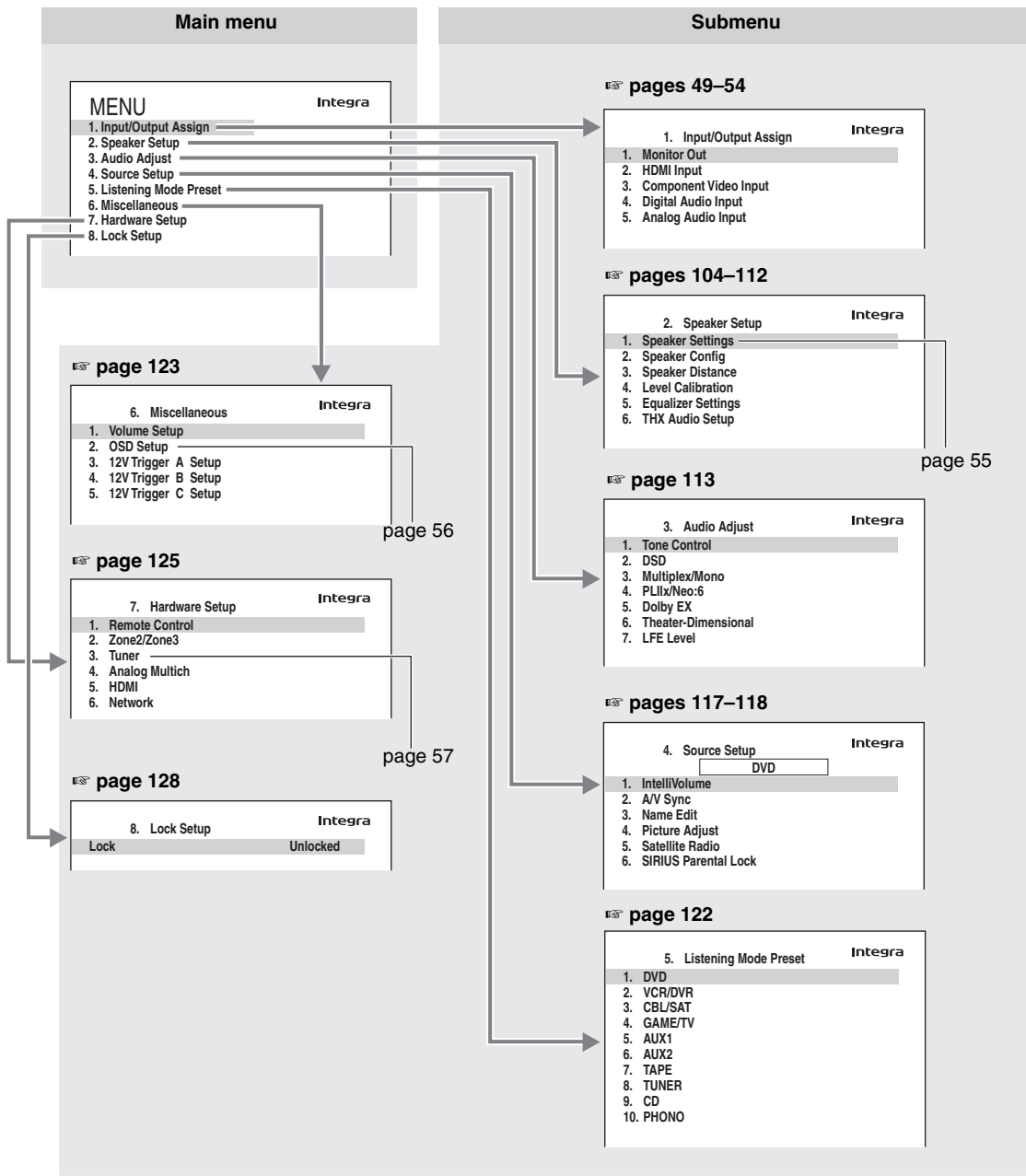

Monitor Out Setup

This section explains items on the “Input/Output Assign” menu.

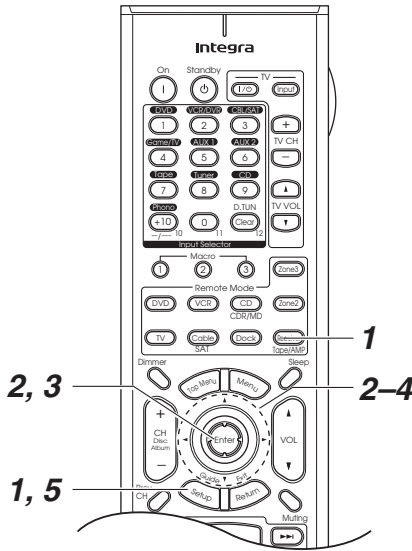

1 Press the [Receiver] button, followed by the [Setup] button. The main menu appears onscreen. If the main menu doesn't appear, make sure the appropriate external input is selected on your TV.

2 Use the Up and Down [▲]/[▼] buttons to select “1. Input/Output Assign”, and then press [Enter]. The “Input/Output Assign” menu appears.

1. Input/Output Assign		Integra
1.	Monitor Out	
2.	HDMI Input	
3.	Component Video Input	
4.	Digital Audio Input	
5.	Analog Audio Input	

3 Use the Up and Down [▲]/[▼] buttons to select an item, and then press [Enter]. The screen for that item appears.

4 Use the Up and Down [▲]/[▼] buttons to select an item, and use the Left and Right [◀]/[▶] buttons to change it. The items are explained below.

5 When you've finished, press the [Setup] button. Setup closes.

Note: This procedure can also be performed on the AV controller by using its [Setup] button, arrow buttons, and [Enter] button.

Monitor Out

Resolution

You can specify the output resolution for the HDMI outputs and have the AV controller upconvert the picture resolution as necessary to match the resolution supported by your TV.

Through: Select this to pass video through the AV controller at the same resolution and with no conversion (default).

Auto: Select this to have the AV controller automatically convert video at resolutions not supported by your TV.
(Not available when the “Monitor Out” setting is set to “Analog”.)

480p (480/576p):

Select this for 480p or 576p output and video conversion as necessary.

720p: Select this for 720p output and video conversion as necessary.

1080i: Select this for 1080i output and video conversion as necessary.

1080p: Select this for 1080p output and video conversion as necessary.
(Not available when the “Monitor Out” setting is set to “Analog”.)

Source: Output will be according to the resolution level which was set with Resolution inside Source: 4-4. Picture Adjust. (Setting for each Source becomes possible.)

Brightness

With this setting you can adjust the picture brightness. Can be adjusted from -50 to +50 in steps of 1 (default is 0).

“-50” is the darkest.
“+50” is the brightest.

Contrast

With this setting you can adjust Contrast. Can be adjusted from -50 to +50 in steps of 1 (default is 0).

“-50” is the least.
“+50” is the greatest.

Hue

With this setting you can adjust the red/green balance. Can be adjusted from -20 to +20 in steps of 1 (default is 0).

“-20” is the strongest green.
“+20” is the strongest red.

Saturation

With this setting you can adjust saturation. Can be adjusted from -50 to +50 in steps of 1 (default is 0).

“-50” is the weakest color.
“+50” is the strongest color.

R Brightness

With this setting you can adjust the picture red brightness.

Can be adjusted from -50 to +50 in steps of 1 (default is 0).

“-50” is the darkest.
“+50” is the brightest.

R Contrast

With this setting you can adjust red Contrast.

Can be adjusted from -50 to +50 in steps of 1 (default is 0).

“-50” is the least.
“+50” is the greatest.

G Brightness

With this setting you can adjust the picture green brightness.

Can be adjusted from -50 to +50 in steps of 1 (default is 0).

“-50” is the darkest.
“+50” is the brightest.

G Contrast

With this setting you can adjust green Contrast.

Can be adjusted from -50 to +50 in steps of 1 (default is 0).

“-50” is the least.
“+50” is the greatest.

B Brightness

With this setting you can adjust the picture blue brightness.

Can be adjusted from -50 to +50 in steps of 1 (default is 0).

“-50” is the darkest.
“+50” is the brightest.

B Contrast

With this setting you can adjust blue Contrast.

Can be adjusted from -50 to +50 in steps of 1 (default is 0).

“-50” is the least.
“+50” is the greatest.

Component Out2

Use this setting if you connect the AV controller’s COMPONENT VIDEO MONITOR OUT 1 or COMPONENT VIDEO MONITOR OUT 2/ZONE 2 OUT to your TV.

Speaker Setup

This section explains items on the “Speaker Setup” menu.

Some of the speaker settings are set automatically by the Automatic Speaker Setup function (see page 58).

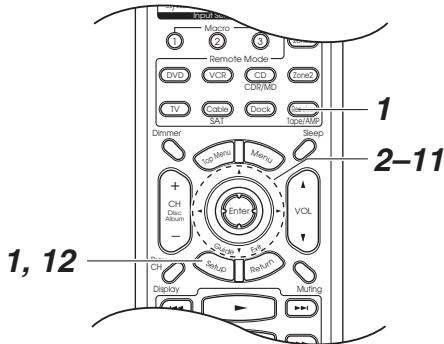

Speaker Settings

See “Speaker Settings” on page 55.

Speaker Configuration

These settings are set automatically by the Automatic Speaker Setup function (see page 58).

With the Speaker Configuration settings, you can specify which speakers are connected and a crossover frequency, distance, and level for each speaker.

The following crossover frequencies can be specified: Full Band, 40 Hz, 45 Hz, 50 Hz, 55 Hz, 60 Hz, 70 Hz, 80 Hz (THX), 90 Hz, 100 Hz, 110 Hz, 120 Hz, 130 Hz, 150 Hz, or 200 Hz.

Specify Full Band for speakers that can output low-frequency bass sounds adequately, for example, speakers with a good sized woofer. For smaller speakers, specify a crossover frequency. Sounds below the crossover frequency will then be output by the subwoofer instead of the speaker. Refer to your speakers’ manuals to determine the optimum crossover frequencies.

If you’re using THX-certified speakers, specify 80 Hz (THX) for all speakers.

1



Press the [Receiver] Remote Mode button, followed by the [Setup] button.

The main menu appears onscreen.

If the main menu doesn’t appear, make sure the appropriate external input is selected on your TV.

2



Use the Up and Down [▲]/[▼] buttons to select “2. Speaker Setup”, and then press [Enter].

The “Speaker Setup” menu appears.

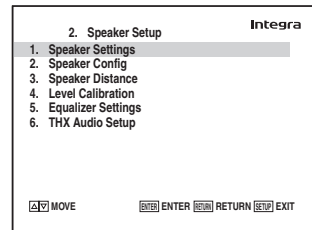

3

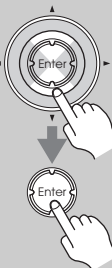

Use the Up and Down [▲]/[▼] buttons to select “2. Speaker Config”, and then press [Enter].

The “Speaker Config” screen appears.

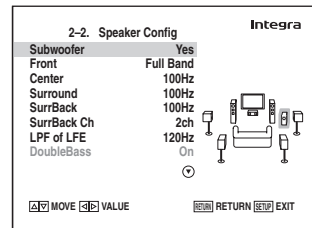

4

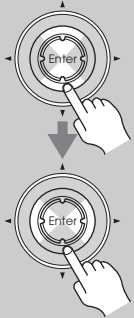

Use the Up and Down [▲]/[▼] buttons to select “Subwoofer”, and then use the Left and Right [◀]/[▶] buttons to select:

Yes: Select if a subwoofer is connected.

No: Select if no subwoofer is connected.

5

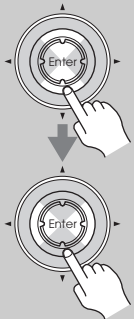

Use the Up and Down [▲]/[▼] buttons to select “Front”, and then use the Left and Right [◀]/[▶] buttons to select a crossover frequency.

Note:

Fixed at “Full Band” if “Subwoofer” (step 4) is set to “No”.

6

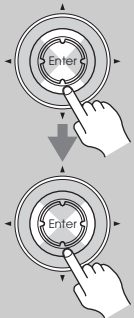

Use the Up and Down [▲]/[▼] buttons to select “Center”, and then use the Left and Right [◀]/[▶] buttons to select a crossover frequency.

If no center speaker is connected, select None.

Note:

Cannot select “Full Band” if “Front” (step 5) is set to anything other than “Full Band”.

7

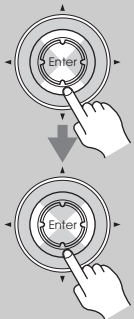

Use the Up and Down [▲]/[▼] buttons to select “Surround”, and then use the Left and Right [◀]/[▶] buttons to select a crossover frequency.

If no surround left and right speakers are connected, select “None”.

Note:

Cannot select “Full Band” if “Front” (step 5) is set to anything other than “Full Band”.

8

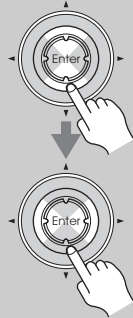

Use the Up and Down [▲]/[▼] buttons to select “SurrBack”, and then use the Left and Right [◀]/[▶] buttons to select a crossover frequency.

If no surround back speakers are connected, select “None”.

Notes:

- Cannot be set if “Speaker Type” is set to “Bi-Amp” (page 55), “Surround” is set to “None” (step 7).
- Cannot select “Full Band” if “Surround” (step 7) is set to anything other than “Full Band”.

9

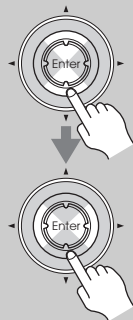

Use the Up and Down [▲]/[▼] buttons to select “SurrBack Ch”, and then use the Left and Right [◀]/[▶] buttons to select:

1ch: Select if one surround back speaker is connected.

2ch: Select if two (left and right) surround back speakers are connected.

Note:

Cannot be set if “Speaker Type” is set to “Bi-Amp” (page 55), “SurrBack” is set to “None” (step 8).

Continue with step 10 on the next page.

Low-Pass Filter for the LFE Channel

This setting is *not* set automatically by the Automatic Speaker Setup function (see page 58).

With this setting, you can specify the cutoff frequency of the LFE channel's low-pass filter (LPF), which can be used to filter out unwanted hum. The LPF only applies to sources that use the LFE channel.

*If you're using THX-certified speakers, select "80Hz(THX)".

10



Use the Up and Down [▲]/[▼] buttons to select "LPF of LFE", and then use the Left and Right [◀]/[▶] buttons to select a low-pass filter frequency.

The following low-pass filter frequencies can be selected: "80Hz(THX)", "90Hz", "100Hz", "110Hz", or "120Hz".

Continue with step 11 in the next column.

Double Bass

This setting is *not* set automatically by the Automatic Speaker Setup function (see page 58).

With this setting, you can boost bass output by feeding front left and right channel bass sounds to the subwoofer.

This setting can only be made if the "Subwoofer" setting in step 4 is set to "Yes", and the "Front" setting in step 5 is set to "Full Band".

*If you're using THX-certified speakers, select "Off(THX)".

11

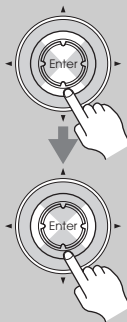

Use the Up and Down [▲]/[▼] buttons to select "DoubleBass", and then use the Left and Right [◀]/[▶] buttons to select:

Off(THX):

The subwoofer only outputs the LFE channel.

On:

In addition to LFE channel sounds, the subwoofer outputs front left and right channel bass sounds.

12



Press the [Setup] button.

Setup close.

Note:

This procedure can also be performed on the AV controller by using its [Setup] button, arrow buttons, and [Enter] button.

Speaker Distance

These settings are set automatically by the Automatic Speaker Setup function (see page 58).

With the “Speaker Distance” settings, you can specify the distance from each speaker to the listening position.

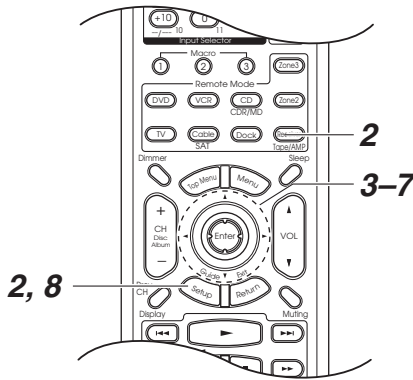

1 Measure and make a note of the distance from each speaker to the listening position.

2 Press the [Receiver] Remote button, followed by the [Setup] button.



The main menu appears onscreen. If the main menu doesn't appear, make sure the appropriate external input is selected on your TV.

3 Use the Up and Down [▲]/[▼] buttons to select “2. Speaker Setup”, and then press [Enter].

The “Speaker Setup” menu appears.

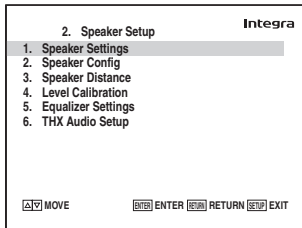
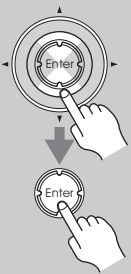

4

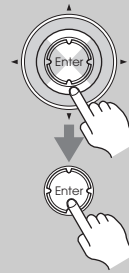

Use the Up and Down [▲]/[▼] buttons to select “3. Speaker Distance”, and then press [Enter].

The “Speaker Distance” screen appears.

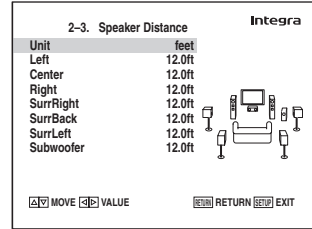

Note:

Speakers that you set to “No” or “None” in the Speaker Configuration (page 104) cannot be selected.

5



Use the Up and Down [▲]/[▼] buttons to select “Unit”, and then use the Left and Right [◀]/[▶] buttons to select:

feet: Select if you want to enter distances in feet. Can be set from 0.2 to 30 feet in 0.2-foot steps.

meters: Select if you want to enter distances in meters. Can be set from 0.06 to 9 meters in 0.06-meter steps.

6



Use the Up and Down [▲]/[▼] buttons to select a speaker, and use the Left and Right [◀]/[▶] buttons to specify the distance.

Specify the distance from the speaker to your listening position.

Notes:

- The “Center” distance cannot be set if the “Center” is set to “None” (page 104).
- The “SurrRight” and “SurrLeft” distances cannot be set if the “Surround” is set to “None” (page 104).
- The “SurrBack R” and “SurrBack L” distances cannot be set if “Speaker Type” is set to “Bi-Amp” (page 55), “SurrBack” is set to “None” (page 104).
- The “Subwoofer” distance cannot be set if “Subwoofer” is set to “No” (page 105).

7

Repeat step 6 for each speaker.

8



Press the [Setup] button.

Setup closes.

Note:

This procedure can also be performed on the AV controller by using its [Setup] button, arrow buttons, and [Enter] button.

Speaker Level Calibration

These settings are set automatically by the Automatic Speaker Setup function (see page 58).

With the “Level Calibration” settings, you can adjust the level of each speaker while listening to the test tone so that the volume of each speaker is the same at the listening position.

Notes:

- The speakers cannot be calibrated while the output of the AV controller is muted.
- The test tone is output at the standard level for THX, which is 0 dB (absolute volume setting 82). If you normally listen at volume settings below this, be careful because the test tone will be much louder.

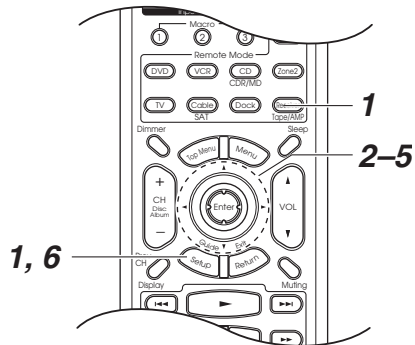

1



Press the [Receiver] Remote button, followed by the [Setup] button.

The main menu appears onscreen.

If the main menu doesn't appear, make sure the appropriate external input is selected on your TV.

2

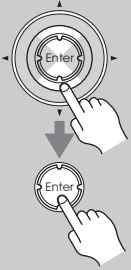

Use the Up and Down [▲]/[▼] buttons to select “2. Speaker Setup”, and then press [Enter].

The “Speaker Setup” menu appears.

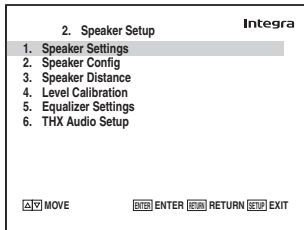

3

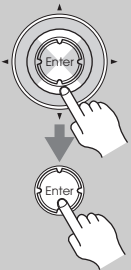

Use the Up and Down [▲]/[▼] buttons to select “4. Level Calibration”, and then press [Enter].

The “Level Calibration” screen appears and the pink noise test tone is output by the front left speaker.

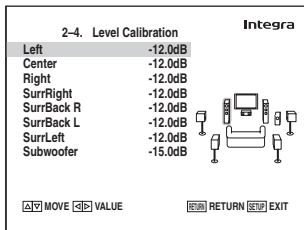

Note:

Levels cannot be adjusted for speakers set to “No” or “None” in the Speaker Configuration (page 104).

4



Use the Up and Down [▲]/[▼] buttons to select a speaker, and use the Left and Right [◀]/[▶] buttons to adjust the level.

Levels can be adjusted from -12 to +12 dB in 0.5 dB steps (-15 to +12 dB for the subwoofer).

Notes:

- The “Center” level cannot be set if the “Center” is set to “None” (page 104).
- The “SurrRight” and “SurrLeft” levels cannot be set if the “Surround” is set to “None” (page 104).
- The “SurrBack R” and “SurrBack L” levels cannot be set if “Speaker Type” is set to “Bi-Amp” (page 55), “SurrBack” is set to “None” (page 104).
- The “Subwoofer” levels cannot be set if “Subwoofer” is set to “No” (page 105).

5

Repeat step 4 until the volume of the test tone from each speaker is the same.

If you’re using a handheld sound level meter, adjust the level of each speaker so that it reads 75 dB SPL at the listening position, measured with C-weighting and slow reading.

6



Press the [Setup] button.

Setup closes.

Notes:

- Speaker levels can also be adjusted by using the dedicated buttons on the remote controller. Press the [Test Tone] button to output the test tone. Use the [CH Sel] button to select each speaker, and use the [Level-] and [Level+] buttons to adjust the level.
- This procedure can also be performed on the AV controller by using its [Setup] button, arrow buttons, and [Enter] button.

Equalizer Settings

These settings are set automatically by the Automatic Speaker Setup function (see page 58).

With the Equalizer settings, you can adjust the tone of speakers individually with a 7-band equalizer. The volume of each speaker can be set on page 108.

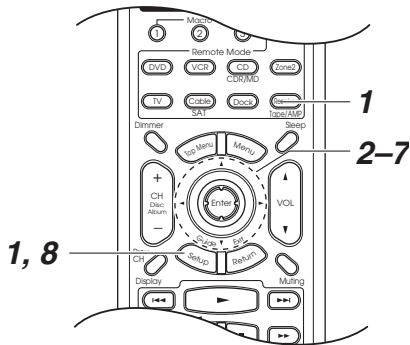

1 Press the [Receiver] Remote Mode button, followed by the [Setup] button. The main menu appears onscreen. If the main menu doesn't appear, make sure the appropriate external input is selected on your TV.

2 Use the Up and Down [▲]/[▼] buttons to select "2. Speaker Setup", and then press [Enter]. The "Speaker Setup" menu appears.

2. Speaker Setup		Integra
1. Speaker Settings		
2. Speaker Config		
3. Speaker Distance		
4. Level Calibration		
5. Equalizer Settings		
6. THX Audio Setup		

3 Use the Up and Down [▲]/[▼] buttons to select "5. Equalizer Settings", and then press [Enter]. The "Equalizer Settings" screen appears.

2-5. Equalizer Settings		Integra
Equalizer	Manual	
Channel	Front	
25Hz	0dB	
40Hz	0dB	
63Hz	0dB	
100Hz	0dB	
160Hz	0dB	
250Hz	0dB	
400Hz	0dB	

2-5. Equalizer Settings		Integra
630Hz	0dB	⊙
1000Hz	0dB	
1600Hz	0dB	
2500Hz	0dB	
4000Hz	0dB	
6300Hz	0dB	
10000Hz	0dB	
16000Hz	0dB	

4 Use the Left and Right [◀]/[▶] buttons to set the "Equalizer" option to:



- ➔ **Off:** Equalizer off, flat response.
- ↕
- Manual:** The equalizer for each speaker can be set manually.
- ↕
- MultEQ XT^{*1}**
- ↕
- Dynamic EQ^{*1}**
- ↕
- Dynamic Vol(Light)^{*1}**
- ↕
- Dynamic Vol(Heavy)^{*1}**

*1 These setting can be selected after having performed the Automatic Speaker Setup. As soon as the Automatic Speaker Setup is complete, it will automatically be set to Dynamic EQ™.

When "Dynamic EQ" is selected, "MultEQ[®] XT" and "Dynamic EQ" become available.

When "Dynamic Vol(Light)" or "Dynamic Vol(Heavy)" is selected, "MultEQ XT", "Dynamic EQ", and "Dynamic Volume™" become available.

If you selected "Manual", continue with the next step. If you selected others go to step 8.

■ MultEQ XT

Audyssey MultEQ XT correction is active (see page 58).

■ Dynamic EQ

“Audyssey MultEQ XT” and “Dynamic EQ” becomes active (see page 58).

■ Dynamic Vol(Light)

“Audyssey MultEQ XT”, “Dynamic EQ”, and “Dynamic Volume (Light Compression Mode)” becomes active (see page 58).

This setting prevents loud and soft sounds from being much louder and softer respectively than average sounds.

■ Dynamic Vol(Heavy)

“Audyssey MultEQ XT”, “Dynamic EQ”, and “Dynamic Volume (Heavy Compression Mode)” becomes active (see page 58).

This setting affects volume the most, causing all sounds to be of equal loudness.

5

Use the Down [▼] button to select “Channel”, and then use the Left and Right [◀]/[▶] buttons to select a speaker.

You can select: “Front”, “Center”, “Surround”, “SurrBack”, or “Subwoofer”.

2-5. Equalizer Settings		Integra
Equalizer	Manual	
Channel	Front	
25Hz	0dB	
40Hz	0dB	
63Hz	0dB	
100Hz	0dB	
160Hz	0dB	
250Hz	0dB	
400Hz	0dB	

6

Use the Up and Down [▲]/[▼] buttons to select a frequency, and then use the Left and Right [◀]/[▶] buttons to adjust the level at that frequency.

You can select: “25Hz”, “40Hz”, “63Hz”, “100Hz”, “160Hz”, “250Hz”, “400Hz”, “630Hz”, “1000Hz”, “1600Hz”, “2500Hz”, “4000Hz”, “6300Hz”, “10000Hz”, or “16000Hz”. And for the subwoofer, “25Hz”, “40Hz”, “63Hz”, “100Hz”, or “160Hz”.

The volume at each frequency can be adjusted from -6 to +6 dB in 1 dB steps.

Tip:

Low frequencies (e.g., 160Hz) affect bass sounds; high frequencies (e.g., 6300Hz) affect treble sounds.

7

Use the Up and Down [▲]/[▼] buttons to select “Channel”, and then use the Left and Right [◀]/[▶] buttons to select another speaker.

Repeat steps 6 and 7 for each speaker.

8

Press the [Setup] button.

The setup menu closes.

Notes:

- When the listening mode is set to Direct, no effect will be produced.
- The Equalizer settings have no effect on 176.4/192 kHz input signals.
- This procedure can also be performed on the AV controller by using its [Setup] button, arrow buttons, and [Enter] button.

THX Audio Setup

These settings are **not** set automatically by the Automatic Speaker Setup function (see page 58).

With the “SurrBack Sp Spacing” setting, you can specify the distance between your surround back speakers.

If you’re using a THX-certified subwoofer, set the “THX Subwoofer” setting to “Yes”. You can then apply THX’s Boundary Gain Compensation (BGC) to compensate the perceived exaggeration of low frequencies for listeners sitting very close to a room boundary (i.e., wall).

You can also set the THX Loudness Plus feature “On” or “Off”. When the “Loudness Plus” is set to “On”, it is possible to enjoy even subtle nuances of audio expression at low volume.

This result is only available when the THX listening mode is selected.

1



Press the [Receiver] Remote Mode button, followed by the [Setup] button.

The main menu appears onscreen.

If the main menu doesn’t appear, make sure the appropriate external input is selected on your TV.

2

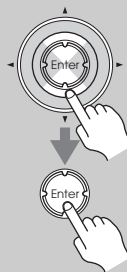

Use the Up and Down [▲]/[▼] buttons to select “2. Speaker Setup”, and then press [Enter].

The “Speaker Setup” menu appears.

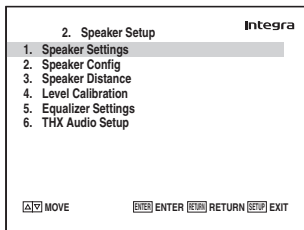

3

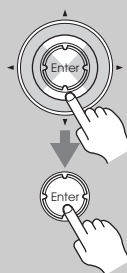

Use the Up and Down [▲]/[▼] buttons to select “6. THX Audio Setup”, and then press [Enter].

The “THX Audio Setup” screen appears.

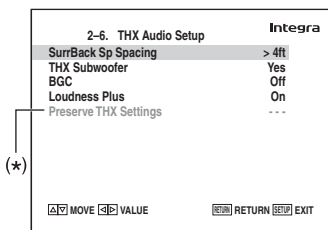

When “Loudness Plus” is set to “Off”, the “Preserve THX settings” can be selected.

4

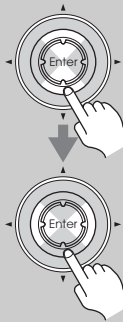

Use the Up and Down [▲]/[▼] buttons to select “SurrBack Sp Spacing”, and use the Left and Right [◀]/[▶] buttons to specify the distance between your surround back speakers:

> 4ft (>1.2m) (Default): Select this if your surround back speakers are more than 4 feet (1.2 m) apart.

< 1ft (< 0.3m): Select this if your surround back speakers are between 0 and 1 foot (0–30 cm) apart.

1ft– 4ft (0.3m–1.2m): Select this if your surround back speakers are between 1 and 4 feet (0.3–1.2 m) apart.

Note:

Cannot be set if “SurrBack Ch” is set to “2ch” (page 105), “Speaker Type” is set to “Bi-Amp” (page 55), “SurrBack” is set to “None” (page 105).

5

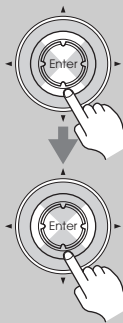

Use the Up and Down [▲]/[▼] buttons to select “THX Subwoofer”, and use the Left and Right [◀]/[▶] buttons to select:

No: Select this if you do not have a THX-certified subwoofer.

Yes: Select this if you have a THX-certified subwoofer.

6

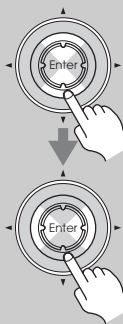

Use the Up and Down [▲]/[▼] buttons to select “BGC”, and use the Left and Right [◀]/[▶] buttons to select:

Off: Select this to turn off BGC.

On: Select this to turn on BGC.

Note:

This setting is only available if “THX Subwoofer” is set to “Yes” (step 5).

7



Use the Up and Down [▲]/[▼] buttons to select “Loudness Plus”, and use the Left and Right [◀]/[▶] buttons to select:

Off: Select this to turn off Loudness Plus.

On: Select this to turn on Loudness Plus (default).

When “Loudness Plus” is set to “Off”, the “Preserve THX settings” selection will appear under “Loudness Plus” (Step 8).

8



Use the Up and Down [▲]/[▼] buttons to select “Preserve THX settings”, and use the Left and Right [◀]/[▶] buttons to select:

Yes: When Yes is selected, Audyssey Dynamic EQ™ / Audyssey Dynamic Volume™ will not be active.

No: When No is selected, Audyssey Dynamic EQ / Audyssey Dynamic Volume will be active in THX listening mode depending on the setting.

Note:

This setting is only available if “Loudness Plus” is set to “Off” (step 7).

9



Press the [Setup] button.

The setup menu closes.

Note:

This procedure can also be performed on the AV controller by using its [Setup] button, arrow buttons, and [Enter] button.

THX Loudness Plus

THX Loudness Plus is a new volume control technology featured in THX Ultra2 Plus™ and THX Select2 Plus™ Certified receivers. With THX Loudness Plus, home theater audiences can now experience the rich details in a surround mix at any volume level. A consequence of turning the volume below Reference Level is that certain sound elements can be lost or perceived differently by the listener. THX Loudness Plus compensates for the tonal and spatial shifts that occur when the volume is reduced by intelligently adjusting ambient surround channel levels and frequency response. This enables users to experience the true impact of soundtracks regardless of the volume setting. THX Loudness Plus is automatically applied when listening in any THX listening mode. The new THX Cinema, THX Music, and THX Games modes are tailored to apply the proper THX Loudness Plus settings for each type of content.

Audio Adjust

Here you can set listening mode-related settings and functions.

1



Press the [Receiver] Remote Mode button, followed by the [Setup] button.

The main menu appears onscreen.

If the main menu doesn't appear, make sure the appropriate external input is selected on your TV.

2

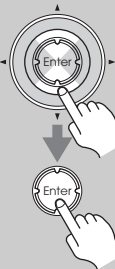

Use the Up and Down [▲]/[▼] buttons to select “3. Audio Adjust”, and then press [Enter].

The “Audio Adjust” menu appears.

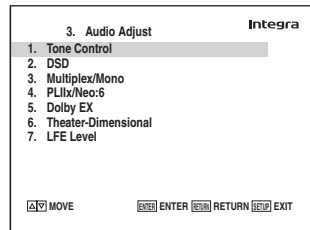

3



Use the Up and Down [▲]/[▼] buttons to select an item, and then press [Enter].

The function menu you selected appears.

4



Use the Up and Down [▲]/[▼] buttons to select the settings, and use the Left and Right [◀]/[▶] buttons to set them.

The settings are explained below.

5



When you've finished, press the [Setup] button.

The setup menu closes.

Note:

This procedure can also be performed on the AV controller by using its [Setup] button, arrow buttons, and [Enter] button.

Tone Control Settings

You can adjust the tone (bass and treble) of the front, center, surround, and surround back speakers individually. For the subwoofer, you can adjust the bass.

■ **Bass**

You can boost or cut low-frequency sounds from -10 dB to +10 dB in 1 dB steps.

■ **Treble**

You can boost or cut high-frequency sounds from -10 dB to +10 dB in 1 dB steps.

Notes:

- The tone control circuits are bypassed when the Direct or THX listening mode is selected.
- This setting is not available when the multichannel Analog input is selected.
- This procedure can also be performed on the AV controller by using its [Tone], Plus [+] and Minus [-] buttons (see page 66).

DSD Setting

■ **DAC Direct**

This setting determines whether or not DSD (SACD) audio signals are passed through the DSP for A/V Sync, delay, etc., processing when the Direct listening mode is selected.

No: DSD signals are processed by the DSP (default).

Yes: DSD signals are not processed by the DSP.

Multiplex/Mono Settings

Multiplex

■ **Input Ch(Mux)**

This setting determines which channel of a stereo multiplex source is output. Use it to select audio channels or languages with multiplex sources, multilingual TV broadcasts, and so on.

Main: The main channel is output (default).

Sub: The sub channel is output.

Main/Sub: Both the main and sub channels are output.

Mono

■ **Input Ch(Mono)**

This setting specifies the channel to be used for playing any 2-channel digital source such as Dolby Digital, or 2-channel analog/PCM source in the Mono listening mode.

L+R: Both the left and right channels are output (default).

L: Only the left channel is output.

R: Only the right channel is output.

■ **Output Speaker**

This setting determines which speakers output mono audio when the Mono listening mode is selected.

C: Mono audio is output by the center speaker (default).

L/R: Mono audio is output by the front left and right speakers.

PLIIx/Neo:6 Settings

PLIIx Music(2ch Input)

These settings apply to only 2-channel stereo sources.

If you're not using any surround back speakers, these settings apply to Dolby Pro Logic II, not Dolby Pro Logic IIx.

■ **Panorama**

With this setting, you can broaden the width of the front stereo image when using the Dolby Pro Logic IIx Music listening mode.

On: Panorama function on.

Off: Panorama function off (default).

■ Dimension

With this setting, you can move the sound field forward or backward when using the Dolby Pro Logic IIx Music listening mode. It can be adjusted from -3 to $+3$. The default value is 0 . Lower settings move the sound field forward. Higher settings move it backward.

If the stereo image feels too wide, or there's too much surround sound, move the sound field forward to improve the balance. Conversely, if the stereo image feels like it's in mono, or there's not enough surround sound, move it backward.

■ Center Width

With this setting, you can adjust the width of the sound from the center speaker when using the Dolby Pro Logic IIx Music listening mode. Normally, if you're using a center speaker, the center channel sound is output by only the center speaker. (If you're not using a center speaker, the center channel sound will be distributed to the front left and right speakers to create a phantom center). This setting controls the front left, right, and center mix, allowing you to adjust the weight of the center channel sound. It can be adjusted from 0 to 7 . The default value is 3 .

Neo:6 Music

■ Center Image

The DTS Neo:6 Music listening mode creates 6-channel surround sound from 2-channel stereo sources. With this setting, you can specify by how much the front left and right channel output is attenuated in order to create the center channel. It can be adjusted from 0 to 5 . The default value is 2 .

When set to 0 , the front left and right channel output is attenuated by half (-6 dB), giving the impression that the sound is located centrally. This setting works well when the listening position is considerably off center. When set to 5 , the front left and right channels are not attenuated, maintaining the original stereo balance.

Dolby EX Settings

■ Dolby EX

This setting determines how Dolby EX signals are handled.

Auto: When the source is Dolby EX, you can select the Dolby EX or THX Surround EX listening mode (default).

Manual: When the source is Dolby EX, you can select any of the listening modes compatible with this format (e.g., Dolby EX, Dolby Pro Logic IIx, etc.).

Theater-Dimensional (T-D) Setting

■ Listening Angle

With this setting, you can optimize the Theater-Dimensional listening mode by specifying the angle of the front left and right speakers relative to the listening position. Ideally, the front left and right speakers should be equidistant from the listening position and at an angle close to one of the two available settings.

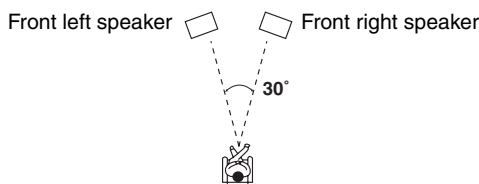

Wide: Select if the angle is greater than 30 degrees (default).

Narrow: Select if the angle is less than 30 degrees.

LFE Level Settings

With these settings, you can set the level of the LFE (Low Frequency Effects) channel individually for Dolby Digital, DTS, and multichannel PCM sources. The level can be set to $-\infty$, -20 dB, -10 dB, or 0 dB (default).

If you find that low-frequency effects are too loud when using one of these sources, change the setting to -20 dB or $-\infty$ dB.

■ Dolby Digital

Sets the level of the LFE channel for Dolby Digital and Dolby Digital Plus sources.

■ DTS

Sets the level of the LFE channel for DTS and DTS-HD High Resolution sources.

■ Multichannel PCM

Sets the level of the LFE channel for multichannel PCM sources. (Multichannel PCM is input via HDMI.)

■ Dolby TrueHD

Sets the level of the LFE channel for Dolby TrueHD sources.

■ DTS-HD Master Audio

Sets the level of the LFE channel for DTS-HD Master Audio sources.

■ DSD

Sets the level of the LFE channel for DSD sources.

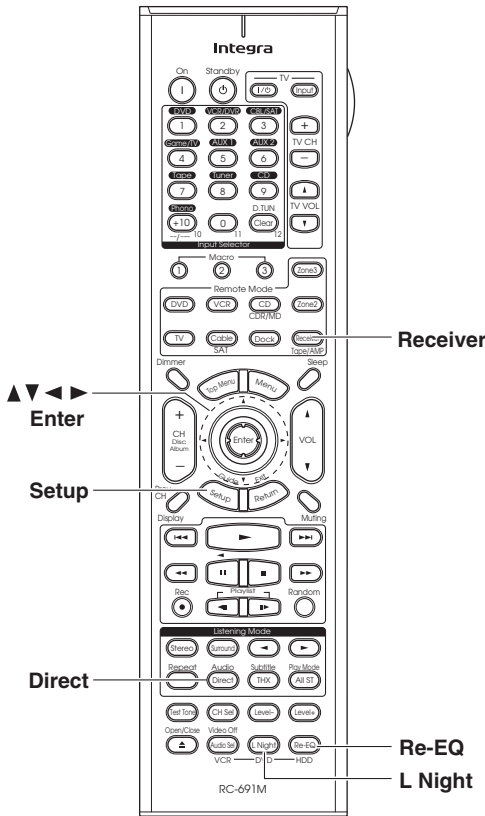

Optimizer

The Music Optimizer function enhances the sound quality of compressed music files. Use it with music files that use “lossy” compression, such as MP3.

Off: Music Optimizer off (default).

On: Music Optimizer on.

Note:

The Music Optimizer function only works with PCM digital audio input signals with a sampling rate below 48 kHz and analog audio input signals. The Music Optimizer is disabled when the Direct listening mode is selected.

Using the Re-EQ Function

With the Re-EQ function, you can compensate a soundtrack whose high-frequency content is too harsh, making it more suitable for home theater viewing.

This function can be used with the following listening modes: Dolby Digital, Dolby Digital EX, Dolby Pro Logic II Movie, Dolby Pro Logic IIx Movie, Dolby Digital Plus, Dolby TrueHD, DTS, DTS-ES, DTS Neo:6 Cinema, DTS-HD High Resolution Audio, DTS-HD Master Audio, DTS 96/24, THX Cinema, THX Surround EX, THX Ultra2 Cinema, Neural THX, DSD and Multichannel.

Using the Music Optimizer

You can change various audio settings by pressing the [Direct] button.

- 1** Remote controller

Press the [Receiver] Remote Mode button, press and hold down the [Direct] button.
The setting item appears on the display.
- 2 Use the Left and Right [◀]/[▶] buttons to change the setting.**
Repeat this step for the other settings.

Press the [Receiver] Remote Mode button, followed by the [Re-EQ] button.
Press the [Re-EQ] button again to turn off the Re-EQ function.

Using the Late Night Function

With the Late Night function, you can reduce the dynamic range of Dolby Digital material so that you can still hear quiet parts even when listening at low volume levels—ideal for watching movies late at night when you don't want to disturb anyone.



Press the [Receiver] Remote Mode button, and then press the [COMPONENT VIDEO MONITOR OUT 1] button repeatedly.

For Dolby Digital and Dolby Digital Plus sources, the options are:

- Off:** Late Night function off (default).
- Low:** Small reduction in dynamic range.
- High:** Large reduction in dynamic range.

For Dolby TrueHD sources, the options are:

- Auto:** The dynamic range is controlled automatically based on the source material and the current volume setting (default).
- Off:** Late Night function off.
- On:** Late Night function on.

Notes:

- The Late Night function can be used only when the input source is Dolby Digital, Dolby Digital Plus, or Dolby TrueHD.
- The effect of the Late Night function depends on the material that you are playing and the intention of the original sound designer, and with some material there will be little or no effect when you select the different options.
- The Late Night function is set to “Off” when the AV controller is set to Standby. For Dolby TrueHD sources, it will be set to “Auto”.

Source Setup

This section explains items on the “Source Setup” menu. Items can be set individually for each input selector.

1



Press the [Receiver] Remote Mode button, and then use the input selector buttons to select an input source.

2



Press the [Setup] button.
The main menu appears onscreen.

3

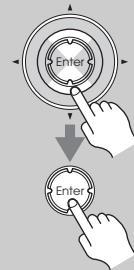

Use the Up and Down [▲]/[▼] buttons to select “4. Source Setup”, and then press [Enter].

The “Source Setup” menu appears. The name of the currently selected input selector is displayed in a box.

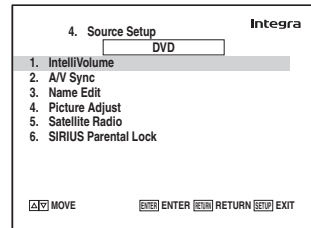

4

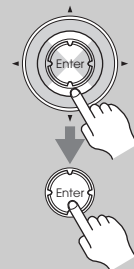

Use the Up and Down [▲]/[▼] buttons to select an item, and then press [Enter].

The screen for that item appears.

5



Use the Up and Down [▲]/[▼] buttons to select an option, and use the Left and Right [◀]/[▶] buttons to change it.

The “Source Setup” menu items are explained below.

6



When you’ve finished, press the [Setup] button.

Setup closes.

IntelliVolume

With IntelliVolume, you can set the input level for each input selector individually. This is useful if one of your source components is louder or quieter than the others.

Use the Left and Right [◀]/[▶] buttons to set the level.

If a component is noticeably louder than the others, use the Left [◀] button to reduce its input level. If it’s noticeably quieter, use the Right [▶] button to increase its input level. The input level can be adjusted from –12 dB to +12 dB in 1 dB steps.

A/V Sync

When using your DVD player’s progressive scanning function, you may find that the picture and sound are out of sync. With the “A/V Sync” setting, you can correct this by applying a delay to the audio signal. The delay can be set from 0 to 250 milliseconds (msec) in 2 millisecond steps.

Use the Up and Down [▲]/[▼] buttons to select an input selector, and use the Left and Right [◀]/[▶] buttons to set the delay.

To view the TV picture while setting the delay, press [Enter].

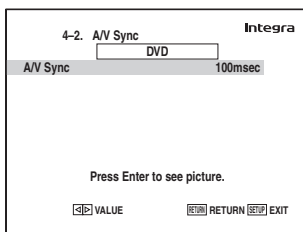

If HDMI Lip Sync is enabled (see page 126), and your TV or display supports HDMI Lip Sync, the displayed delay time will be the A/V Sync delay time. The HDMI Lip Sync delay time is displayed underneath in parentheses.

Note:

A/V Sync cannot be set when the Direct listening mode is used with an analog input source.

Name Edit

You can enter a custom name for each individual input selector and radio preset for easy identification. When entered, the custom name will appear on the display.

The custom name is edited using the character input screen.

1. Use the arrow [▲]/[▼]/[◀]/[▶] buttons to select a character, and then press [Enter].
Repeat this step to enter up to 10 characters.
2. When you’ve finished, to store a name, be sure to use the arrow [▲]/[▼]/[◀]/[▶] buttons to select “OK”, and then press [Enter]. Otherwise it will not be saved.

Name input area

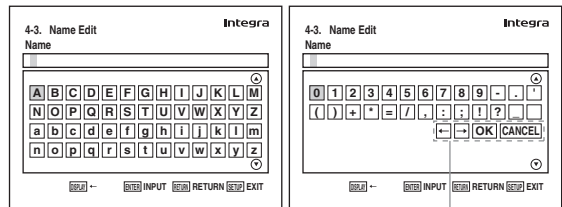

← (Left)/ → (Right):

Selected when the cursor is moved within the Name input area.

OK:

Selects when the entry is complete.

CANCEL:

Selects when you want to cancel the name entry.

To correct a character:

1. Use the arrow [▲]/[▼]/[◀]/[▶] buttons to select “←”(Left) or “→”(Right) and then press [Enter].
2. Press [Enter] several times to select the incorrect character (The cursor moves one letter each time [Enter] is pressed).
3. Use the arrow [▲]/[▼]/[◀]/[▶] buttons to select the correct character, and then press [Enter].

Notes:

- To name a radio preset, use the [Tuner] button to select AM or FM, and then select the preset (see step 1 on page 117).
- You cannot enter a custom name for XM or SIRIUS radio presets.
- To restore a custom name to the default, erase the custom name by entering an empty white space for each letter.
- This procedure can also be performed on the AV controller by using its [Setup] button, arrow buttons, and [Enter] button.

Picture Adjust

The new “4-4. Picture Adjust” item has been added to the “1. Input/Output Assign” menu. This menu and its settings can be accessed just like the other menus. The settings are explained below.

■ Game Mode

If video signal delay occurs during play on a video component, such as a Game console, connected to the AV controller, select “Game Mode” on the input selector connected to the component and set it to “On”.

Use the Left and Right [◀]/[▶] buttons to select:

Off: Game Mode off (default).

On: Game Mode on.

■ Zoom Mode

This setting determines the aspect ratio.

Normal:

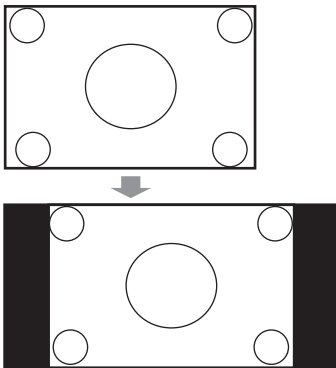

Full: (default)

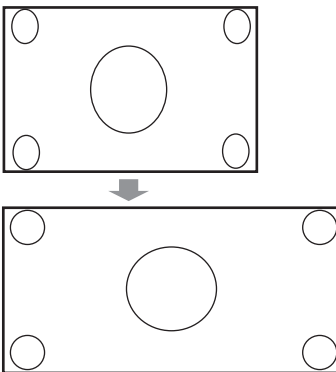

Zoom:

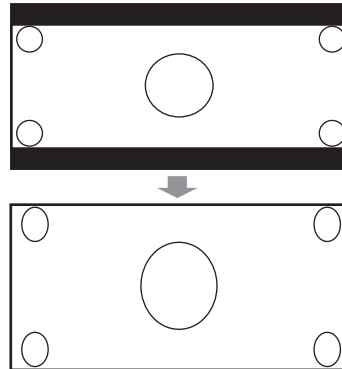

WideZoom:

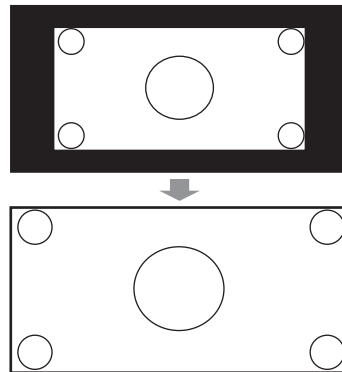

Note:

The “Zoom Mode” can also be set using the [Display] button on the remote controller.

1. Press and hold the [Display] button until the setting item appears on the display.
2. Use the Up and Down [▲]/[▼] buttons to select “Zoom Mode”, and use the Left and Right [◀]/[▶] buttons to change the setting.

■ ISF Mode

The receiver has been designed to incorporate setup and calibration standards established by the Imaging Science Foundation (ISF). The ISF has developed carefully crafted, industry-recognized standards for optimal video performance and has implemented a training program for technicians and installers to use these standards to obtain optimal picture quality from the receiver. Accordingly, recommends that setup and calibration be performed by an ISF Certified installation technician.

Custom: User setting (All items can be freely set.)

Day: Setting when a room is bright.

Night: Setting when a room is dark.

Note:

When “ISF Mode” is selected, the setting from “Resolution” to “B Contrast” is changed.

Resolution

You can specify the output resolution for the HDMI outputs and have the AV controller upconvert the picture resolution as necessary to match the resolution supported by your TV.

Available only when Source has been selected under the “1-1. Monitor Out” setting.

Through: Select this to pass video through the AV controller at the same resolution and with no conversion (default).

Auto: Select this to have the AV controller automatically convert video at resolutions not supported by your TV.

When the “Monitor Out” is set to “Analog”, it will operate as “Through”.

480p (480/576p):

Select this for 480p or 576p output and video conversion as necessary.

720p: Select this for 720p output and video conversion as necessary.

1080i: Select this for 1080i output and video conversion as necessary.

1080p: Select this for 1080p output and video conversion as necessary.

When the “Monitor Out” is set to “Analog”, it will operate as “1080i”.

Brightness

With this setting you can adjust the picture brightness. Can be adjusted from -50 to +50 in steps of 1 (default is 0).

“-50” is the darkest.

“+50” is the brightest.

Contrast

With this setting you can adjust Contrast. Can be adjusted from -50 to +50 in steps of 1 (default is 0).

“-50” is the least.

“+50” is the greatest.

Hue

With this setting you can adjust the red/green balance. Can be adjusted from -20 to +20 in steps of 1 (default is 0).

“-20” is the strongest green.

“+20” is the strongest red.

Saturation

With this setting you can adjust saturation. Can be adjusted from -50 to +50 in steps of 1 (default is 0).

“-50” is the weakest color.

“+50” is the strongest color.

Picture Mode

DVD-Video disc content originates from either film (recorded at 24 frames per second) or video intended for TV (recorded at 30 frames per second). With the default Picture Mode setting of Auto, the AV controller automatically detects the type of content and processes it accordingly to achieve the best picture quality. If the AV controller detects the type of content incorrectly due to characteristics of the disc, you can select Video or Film manually.

Auto: The type of content is detected automatically and processed accordingly (default).

Video: Select when playing a DVD-Video disc whose content originates from video.

Film: Select when playing a DVD-Video disc whose content originates from film.

Edge Enhancement

With Edge Enhancement, you can make the picture appear sharper.

Off: Edge enhancement off (default).

Low: Low edge enhancement.

Medium: Medium edge enhancement.

High: High edge enhancement.

Mosquito NR

With Mosquito Noise Reduction, you can remove the shimmering or haziness that sometimes appears around objects in the picture. Mosquito noise can be an issue with overly compressed MPEG content.

Off: Mosquito noise reduction off (default).

Low: Low mosquito noise reduction.

Medium: Medium mosquito noise reduction.

High: High mosquito noise reduction.

Random NR

With Random Noise Reduction, you can remove indiscriminate picture noise, such as film grain.

Off: Random noise reduction off (default).

Low: Low random noise reduction.

Medium: Medium random noise reduction.

High: High random noise reduction.

Block NR

With Block Noise Reduction, you can remove the block distortion that sometimes appears in the picture. Block noise can be an issue with overly compressed MPEG content.

Off: Block noise reduction off (default).

On: Block noise reduction on.

Gamma

Adjust the balance of incoming picture R (red), G (green), and B (blue) color data signal to the output color data signal.

Can be adjusted from -3 to +3 in steps of 1 (default is 0).

Advanced Setup—Continued

R Brightness:

With this setting you can adjust the picture red brightness.

Can be adjusted from -50 to +50 in steps of 1 (default is 0).

“-50” is the darkest.

“+50” is the brightest.

R Contrast:

With this setting you can adjust red Contrast.

Can be adjusted from -50 to +50 in steps of 1 (default is 0).

“-50” is the least.

“+50” is the greatest.

G Brightness:

With this setting you can adjust the picture green brightness.

Can be adjusted from -50 to +50 in steps of 1 (default is 0).

“-50” is the darkest.

“+50” is the brightest.

G Contrast:

With this setting you can adjust green Contrast.

Can be adjusted from -50 to +50 in steps of 1 (default is 0).

“-50” is the least.

“+50” is the greatest.

B Brightness:

With this setting you can adjust the picture blue brightness.

Can be adjusted from -50 to +50 in steps of 1 (default is 0).

“-50” is the darkest.

“+50” is the brightest.

B Contrast:

With this setting you can adjust blue Contrast.

Can be adjusted from -50 to +50 in steps of 1 (default is 0).

“-50” is the least.

“+50” is the greatest.

Satellite Radio

This item is for use with satellite radio. It's not available if “Satellite Radio” is set to “None” (see page 75). See the separate Satellite Radio Guide for more information.

SIRIUS Parental Lock

This item is for use with SIRIUS Satellite Radio. It's not available if “Satellite Radio” is set to “None” or “XM” (see page 75). See the separate Satellite Radio Guide for more information.

Listening Mode Presets

On the “Listening Mode Preset” menu, you can specify a default listening mode for each of the audio formats supported by each input selector. The AV controller will then select the listening mode automatically depending on the format of the input signal. You can still select the other listening modes, although the default listening mode will be used the next time you turn on the AV controller.

1



Press the [Receiver] Remote Mode button, followed by the [Setup] button.

The main menu appears onscreen. If the main menu doesn't appear, make sure the appropriate external input is selected on your TV.

2

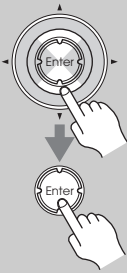

Use the Up and Down [▲]/[▼] buttons to select “5. Listening Mode Preset”, and then press [Enter].

The “Listening Mode Preset” menu appears.

5. Listening Mode Preset		Integra
1. DVD		
2. VCR/DVR		
3. CBL/SAT		
4. GAME/TV		
5. AUX1		
6. AUX2		
7. TAPE		
8. TUNER		
9. CD		
10. PHONO		
[ENTER] MOVE [ENTER] ENTER [RETURN] RETURN [EXIT] EXIT		

3

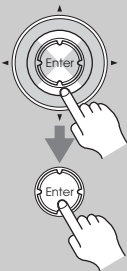

Use the Up and Down [▲]/[▼] buttons to select an input selector, and then press [Enter].

The audio formats supported by that input selector appear.

5-x. Listening Mode Preset		Integra
DVD		
Analog/PCM	Last Valid	
Dolby Digital	Last Valid	
DTS	Last Valid	
D.F. 2ch	Last Valid	
D.F. Mono	Last Valid	

If the input selector is assigned to an HDMI IN, use the Down [▼] button to select the audio formats shown on the following screen.

5-x. Listening Mode Preset		Integra
DVD		
Multich PCM	Last Valid	
192k/176.4k	Last Valid	
Dolby TrueHD	Last Valid	
DTS-HD Master Audio	Last Valid	
DSD	Last Valid	

For the “Tuner” input selector, “Analog” is the only format available.

4



Use the Up and Down [▲]/[▼] buttons to select an audio format, and use the Left and Right [◀]/[▶] buttons to select a listening mode.

Only listening modes compatible with the audio format can be selected (see page 91).

Analog/PCM: Specifies the default listening mode for analog and PCM sources.

Dolby Digital: Specifies the default listening mode for Dolby Digital and Dolby Digital plus sources.

DTS: Specifies the default listening mode for DTS and DTS-HD High Resolution sources.

D.F. 2ch: Specifies the default listening mode for 2-channel (2/0) stereo sources in a digital format, such as Dolby Digital or DTS.

D.F. Mono: Specifies the default listening mode for mono sources in a digital format, such as Dolby Digital or DTS.

Multich PCM: Specifies the default listening mode for multichannel PCM sources, such as DVD-Audio.

192k/176.4k: Specifies the default listening mode for high resolution 192 kHz and 176.4 kHz digital sources, such as DVD-Audio. (input via HDMI)

Dolby TrueHD: Specifies the default listening mode for Dolby TrueHD sources, such as Blu-ray or HD DVD (input via HDMI).

DTS-HD Master Audio: Specifies the default listening mode for DTS-HD Master Audio sources, such as Blu-ray or HD DVD (input via HDMI).

DSD: Specifies the default listening mode for DSD multichannel sources, such as SACD (input via HDMI).

5



When you've finished, press the [Setup] button.

Setup closes.

Note:

This procedure can also be performed on the AV controller by using its [Setup] button, arrow buttons, and [Enter] button.

Miscellaneous Setup

This section explains items on the “Miscellaneous” menu.

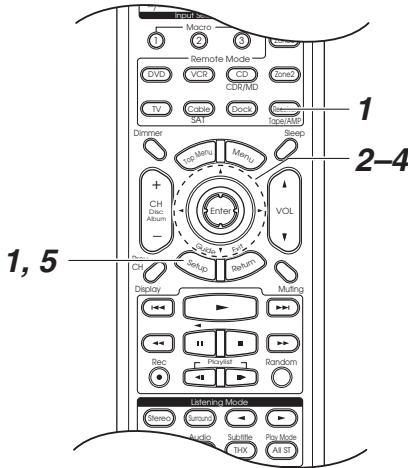

4

Use the Up and Down [▲]/[▼] buttons to select an item, and use the Left and Right [◀]/[▶] buttons to change it.



The items are explained below.

5

When you've finished, press the [Setup] button.

Setup closes.



1

Press the [Receiver] Remote Mode button, followed by the [Setup] button.

The main menu appears onscreen. If the main menu doesn't appear, make sure the appropriate external input is selected on your TV.



2

Use the Up and Down [▲]/[▼] buttons to select “6. Miscellaneous”, and then press [Enter].

The “Miscellaneous” menu appears.

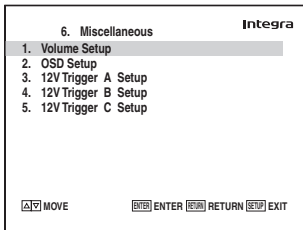
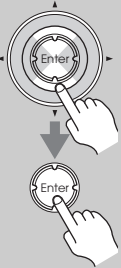

3

Use the Up and Down [▲]/[▼] buttons to select an item, and then press [Enter].

The screen for that item appears.



Note:

This procedure can also be performed on the AV controller by using its [Setup] button, arrow buttons, and [Enter] button.

Volume Setup

■ Volume Display

With this setting, you can choose how the volume level is displayed.

Absolute: Display range is “Min”, 0.5 through 99.5, “Max”.

Relative: Display range is $-\infty$ dB, -81.5 dB through $+18.0$ dB.

The absolute value 82 is equivalent to the relative value 0 dB.

■ Muting Level

This setting determines how much the output is muted when the Muting function is used (see page 65). It can be set to $-\infty$ dB (fully muted) or from -50 dB to -10 dB in 10 dB steps.

■ Maximum Volume

With this setting, you can limit the maximum volume.

When the “Volume Display” setting is set to “Absolute”, the “Maximum Volume” range is “Off”, 99 to 50. When it's set to “Relative”, the range is “Off”, $+17$ dB to -32 dB. To disable this setting, select “Off”.

■ Power On Volume

This setting determines what the volume will be each time the AV controller is turned on.

When the “Volume Display” preference is set to “Absolute”, the range is “Last”, “Min”, 1 to “Max”. When it’s set to “Relative”, the range is “Last”, $-\infty$ dB, -81 dB to $+18$ dB.

To use the same volume level as when the AV controller was last turned off, select “Last”.

Note:

The “Power On Volume” setting cannot be set higher than the “Maximum Volume” setting.

■ Headphone Level

With this setting, you can offset the headphone volume relative to the main volume. This is useful if your headphones are too loud or too quiet at the volume setting you usually use when listening through your speakers. The headphone level can be set from -12 dB to $+12$ dB.

■ Zone2 Maximum Volume

With this setting, you can limit the maximum volume for Zone 2.

When the “Volume Display” setting is set to “Absolute”, the “Maximum Volume” range is “Off”, 99 to 50. When it’s set to “Relative”, the range is “Off”, $+17$ dB to -32 dB. To disable this setting, select “Off”.

■ Zone2 Power On Volume

This setting determines what the volume will be for Zone 2 each time the AV controller is turned on.

When the “Volume Display” preference is set to “Absolute”, the range is “Last”, “Min”, 1 to “Max”. When it’s set to “Relative”, the range is “Last”, $-\infty$ dB, -81 dB to $+18$ dB.

To use the same volume level as when the AV controller was last turned off, select “Last”.

■ Zone3 Maximum Volume

With this setting, you can limit the maximum volume for Zone 3.

When the “Volume Display” setting is set to “Absolute”, the “Maximum Volume” range is “Off”, 99 to 50. When it’s set to “Relative”, the range is “Off”, $+17$ dB to -32 dB. To disable this setting, select “Off”.

■ Zone3 Power On Volume

This setting determines what the volume will be for Zone 3 each time the AV controller is turned on.

When the “Volume Display” preference is set to “Absolute”, the range is “Last”, “Min”, 1 to “Max”. When it’s set to “Relative”, the range is “Last”, $-\infty$ dB, -81 dB to $+18$ dB.

To use the same volume level as when the AV controller was last turned off, select “Last”.

OSD Setup

■ Immediate Display

This setting determines whether operation details are displayed onscreen immediately after an AV controller function is used.

On: Displayed (default).

Off: Not displayed.

Even when “On” is selected, operation details may not be output if the input source is connected to a COMPONENT VIDEO IN or HDMI IN.

For optimal video performance, THX recommends that “Immediate Display” be turned off.

■ Monitor Type

With this setting, you can specify the aspect ratio of your TV so that menus are displayed properly.

4:3: Select if your TV is 4:3.

16:9: Select if your TV is 16:9 (default).

■ Display Position

This setting determines where on the screen operation details are displayed.

Bottom: Bottom of the screen (default).

Top: Top of the screen.

■ TV Format (not North American models)

See “TV Format Setup (not North American models)” on page 56.

■ Language

This setting determines the language used for the onscreen setup menus. You can select: English, German, French, Spanish, Italian, Dutch, Swedish, or Japanese.

12V Trigger A/B/C Setup

See “Using the 12V Triggers” on page 135.

Hardware Setup

This section explains items on the Hardware menu.

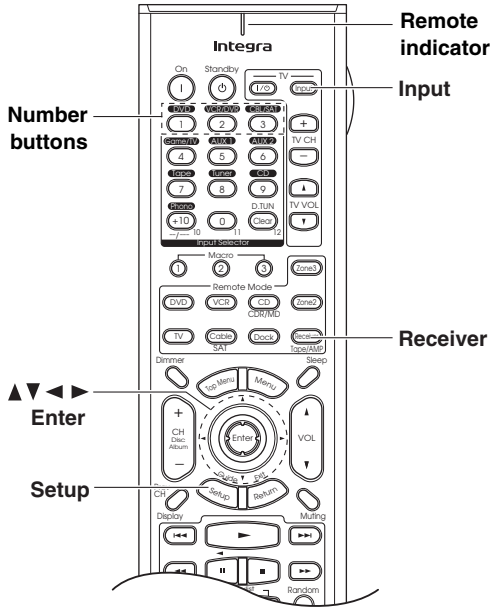

1 Press the [Receiver] Remote Mode button, followed by the [Setup] button. The main menu appears onscreen. If the main menu doesn't appear, make sure the appropriate external input is selected on your TV.

2 Use the Up and Down [▲]/[▼] buttons to select "7. Hardware Setup", and then press [Enter]. The "Hardware Setup" menu appears.

7. Hardware Setup Integra

- 1. Remote Control
- 2. Zone2/Zone3
- 3. Tuner
- 4. Analog Multich
- 5. HDMI
- 6. Network

[Left Arrow] MOVE [Enter] ENTER [Right Arrow] RETURN [Power] EXIT

3 Use the Up and Down [▲]/[▼] buttons to select an item, and then press [Enter]. The screen for that item appears.

4 Use the Up and Down [▲]/[▼] buttons to select an item, and use the Left and Right [◀]/[▶] buttons to change it. The items are explained below.

5 When you've finished, press the [Setup] button. Setup closes.

Note: This procedure can also be performed on the AV controller by using its [Setup] button, arrow buttons, and [Enter] button.

Remote Control

Remote ID
When several Integra/Onkyo components are used in the same room, their remote ID codes may overlap. To differentiate the AV controller from the other components, you can change its remote ID from 1, the default, to 2 or 3.

Note: If you do change the AV controller's remote ID, be sure to change the remote controller to the same ID (see below), otherwise, you won't be able to control it with the remote controller.

Changing the Remote Controller's ID

1 While holding down the [Receiver] Remote Mode button, press the TV [Input] button. The Remote indicator flashes four times.

2 Use the number buttons to enter ID 1, 2, or 3. The Remote indicator flashes twice.

Zone2/Zone3

See "Zone 2 and Zone 3" on page 130.

Tuner

■ AM Freq Step (on some models)

See “AM Frequency Step Setup (on some models)” on page 57.

■ Satellite Radio (on North American model)

If you connect an XM Satellite Radio antenna or SIRIUS Satellite Radio antenna to the AV controller (both sold separately), set this setting to XM or SIRIUS respectively. If you connect both types of antenna, select XM/SIRIUS. Otherwise, select None (see pages 74–88).

Analog Multich

■ Subwoofer Input Sensitivity

Some DVD players output the LFE channel from their analog subwoofer output at 15 dB higher than normal. With this setting, you can change the AV controller’s subwoofer sensitivity to match your DVD player. Note that this setting only affects signals connected to the AV controller’s MULTI CH: SUBWOOFER jack.

You can select 0 dB, 5 dB, 10 dB, or 15 dB.

If you find that your subwoofer is too loud, try the 10 dB or 15 dB setting.

HDMI

■ Audio TV Out

This setting determines whether audio received by an HDMI input is output by the HDMI outputs. You may want to change this setting to “On” if your TV is connected to an HDMI output and you want to listen to audio from an HDMI component through your TV’s speakers. Normally, it should be set to “Off”.

Off: HDMI audio is not output (default).

On: HDMI audio is output.

Notes:

- If “On” is selected and the signal can be output by the TV, the AV controller will output no sound through its speakers.
- When “TV Control” is enabled, this setting is set to “Auto”.
- With some TVs and input signals, no sound may be output even if “On” is selected.
- When the “Audio TV Out” setting is set to “On”, or “TV Control” is set to “Enable” and you’re listening through your TV’s speakers (see page 38), if you turn up the AV controller’s volume control, the sound will be output by the AV controller’s speakers. To stop the AV controller’s speakers producing sound, change the settings, change your TV’s settings, or turn down the AV controller’s volume.

■ Lip Sync

The Lip Sync function can automatically synchronize HDMI audio and video that’s gotten out of sync due to the complex digital video processing being performed by your HDMI-compatible TV. With HDMI Lip Sync, the audio delay required to synchronize the audio and video is calculated and applied automatically by the AV controller.

Disable: HDMI lip sync disabled (default).

Enable: HDMI lip sync enabled.

Notes:

- This function works only if your HDMI-compatible TV supports HDMI Lip Sync.
- You can check the amount of delay being applied by the HDMI Lip Sync function on the “A/V Sync” screen (see page 118).

■ x.v.Color

If your HDMI source and HDMI-compatible TV both support the “x.v.Color”, you can enable “x.v.Color” on the AV controller with this setting.

Disable: “x.v.Color” disabled (default).

Enable: “x.v.Color” enabled.

Notes:

- If the color is unnatural when “x.v.Color” is set to “Enable”, change the setting to “Disable”.
- Refer to the connected component’s instruction manual for details.

■ Control

This function allows **RiHD**-compatible components connected via HDMI to be controlled with the AV controller.

Disable: **RiHD** disabled (default).

Enable: **RiHD** enabled.

Notes:

- **RiHD**, which stands for Remote Interactive over HDMI, is the name of the system control function found on Onkyo components. The AV controller can be used with CEC (Consumer Electronics Control), which allows system control over HDMI and is part of the HDMI standard. CEC provides interoperability between various components, however, operation with components other than **RiHD**-compatible components cannot be guaranteed.
- Set to “Disable” when a connected piece of equipment is not compatible or it is unclear whether the equipment is compatible or not.
- If movement is unnatural when set to “Enable”, change the setting to “Disable”.
- Refer to the connected component’s instruction manual for details.

Advanced Setup—Continued

Power Control

To link the power functions of **RIHD**-compatible components connected via HDMI, select “Enable”.

Disable: Power Control disabled.

Enable: Power Control enabled.

Notes:

- The “Power Control” setting can be set only when the above “Control” setting is set to “Enable”.
- HDMI power control only works with **RIHD**-compatible components that support it and may not work properly with some components due to their settings or compatibility.
- When set to “Enable”, power consumption will increase.
- Refer to the connected component’s instruction manual for details.

TV Control

Set to “Enable” when you want to control the AV controller from an **RIHD**-compatible TV that is connected to HDMI.

Disable: TV Control disabled.

Enable: TV Control enabled.

Notes:

- Set to “Disable” when the TV is not compatible or when it is unclear whether the TV is compatible or not.
- The “TV Control” setting can be set only when the above “Control” and “Power Control” settings are both set to “Enable”.
- Refer to the connected component’s instruction manual for details.

Note:

After changing the settings of the “Control”, “Power Control”, or “TV Control”, turn off the power to all connected pieces of equipment and then turn on again. Refer to the User’s Manuals for all connected pieces of equipment.

When linking to a TV that conforms to the CEC standard, the “Monitor Out” setting must be set to “HDMI Main”.

Network Settings

Note:

When modifying network settings, after modifying it is necessary to execute → Save Settings.

This section explains how to configure the AV controller’s network settings manually.

If your router’s DHCP server is enabled, you don’t need to change any of these settings, as the AV controller is set use DHCP to configure itself automatically by default (i.e., DHCP is set to Enable). If, however, your router’s DHCP server is disabled, for example, you’re using static IP addresses, you’ll need to configure these settings yourself, in which case, a knowledge of Ethernet networking is essential.

What’s DHCP?

DHCP (Dynamic Host Configuration Protocol) is used by routers, computers, the AV controller, and other devices to automatically configure themselves on a network.

1



Press the [Receiver] Remote Mode button, followed by the [Setup] button.

The main menu appears onscreen.

If the main menu doesn’t appear, make sure the appropriate external input is selected on your TV.

2

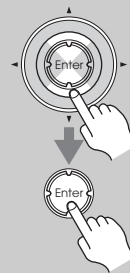

Use the Up and Down [▲]/[▼] buttons to select “7. Hardware Setup”, and then press [Enter].

The “Hardware Setup” menu appears.

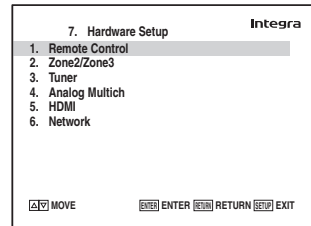

3

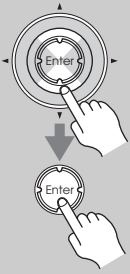

Use the Up and Down [▲]/[▼] buttons to select “6. Network”, and then press [Enter].

The “Network” screen appears.

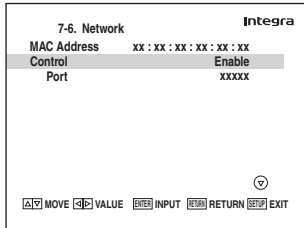

4



Use the Up and Down [▲]/[▼] buttons to select the settings, and use the Left and Right [◀]/[▶] buttons to set them.

To enter an IP address, select the setting, and then press [Enter]. The arrow [▲]/[▼]/[◀]/[▶] buttons can then be used to enter numbers. Press [Enter] again to set the number.

The settings are explained on the next page.

5



When you’ve finished, press the [Setup] button.

Setup closes.

Note:

This procedure can also be performed on the AV controller by using its [Setup] button, arrow buttons, and [Enter] button.

Mac Address

This is the AV controller’s MAC (Media Access Control) address. This address cannot be changed.

Control

This setting enables or disables control over the network.

Enable: Control over the network enabled.

Disable: Control over the network disabled.

Port

This is the network port used for control over the network.

DHCP

This setting determines whether or not the AV controller uses DHCP to automatically configure its IP Address, Subnet Mask, and Gateway settings.

Enable: DHCP enabled.

Disable: DHCP disabled.

If you select “Disable”, you must configure the “IP Address”, “Subnet Mask”, and “Gateway” settings yourself.

IP Address

If you set the “DHCP” setting to “Disable”, you must specify an IP address. Enter a static IP address provided by your ISP.

The IP address must be within the following ranges.

Class A: 10.0.0.0 to 10.255.255.255

Class B: 172.16.0.0 to 172.31.255.255

Class C: 192.168.0.0 to 192.168.255.255

Most routers use Class C IP addresses.

Subnet Mask

If you set the “DHCP” setting to “Disable”, you must specify a subnet mask address.

Enter the subnet mask address provided by your ISP (typically: 255.255.255.0).

Gateway

If you set the “DHCP” setting to “Disable”, you must specify a gateway address.

Enter the gateway address provided by your ISP.

Lock Setup

Lock

With this setting, you can protect your settings by locking the setup menus.

Locked: Setup menus locked.

Unlocked: Setup menus unlocked (default).

When Locked is selected, only this “Lock Setup” item can be accessed.

Selecting Audio Inputs

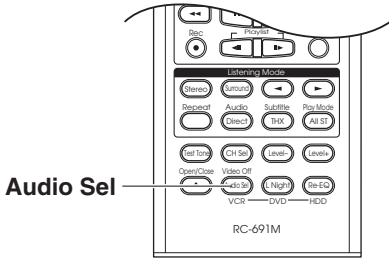

If you connect a component to more than one audio input, such as a DVD player connected to analog, digital, multichannel, and HDMI inputs, you can use the [Audio Sel] button to select which audio input you want to use to listen to that component.



Press the [Audio Sel] button repeatedly to select an audio input: HDMI > Auto > Multich > Analog.

HDMI:

Selects the assigned HDMI IN, and the HDMI indicator appears on the display. (The HDMI IN must already be assigned to the current input selector. See page 50.)

Auto:

Selects the assigned COAXIAL or OPTICAL DIGITAL IN, and the DIGITAL indicator appears on the display. (The DIGITAL IN must already be assigned to the current input selector. See page 53.) If there is no digital signal, the analog input is used instead.

Multich:

Selects the multichannel input, and the ANALOG indicator appears on the display. (The multichannel input must already be assigned to the current input selector. See page 54.)

Analog:

Selects the analog input, and the ANALOG indicator appears on the display.

If you assign the balanced input to the input selector, the sound will be output from equipment connected to the BALANCED L and R INPUT XLR jacks (see page 54).

Specifying the Digital Signal Format

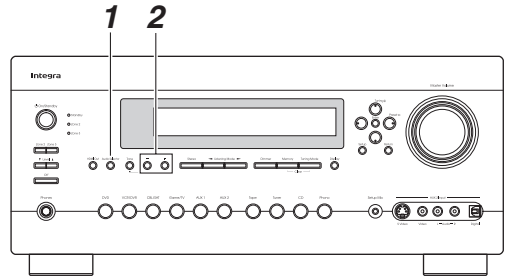

Normally, the AV controller detects the format of digital input signals automatically. However, if you experience either of the following issues when playing PCM or DTS sources, you can specify the signal format manually.

- If the beginnings of tracks from a PCM source are cut off, try the PCM setting.
- If noise is produced when fast forwarding or rewinding a DTS CD, try the DTS setting.

1

Audio Selector



Press the [Audio Selector] button repeatedly to select “Auto”.

2

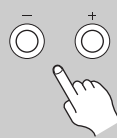

While “Auto” is shown on the display, use the Tone Plus [+] and Minus [-] buttons to select:

PCM:

Only 2-channel PCM format input signals will be heard. If the input signal is not PCM, the PCM indicator will flash and noise may also be produced.

DTS:

Only DTS (but not DTS-HD) format input signals will be heard. If the input signal is not DTS, the DTS indicator will flash and there will be no sound.

Auto (default):

The format is detected automatically. If no digital input signal is present, the analog input is used instead.

Zone 2 and Zone 3

In addition to your main listening room, you can also enjoy playback in two other rooms, or as we call them, Zone 2 and Zone 3. And, you can select a different source for each room.

Connecting Zone 2

Zone 2 speakers must be connected to an amp in Zone 2.

Connecting Your Zone 2 Speakers

You can enjoy 2-channel stereo playback in Zone 2 and a different source to those selected for your main room and Zone 3.

Hookup

- Use an RCA audio cable to connect the AV controller's ZONE 2 PRE OUT L/R jacks to an analog audio input on your Zone 2 amp.
- Use an RCA audio cable to connect the AV controller's ZONE 2 PRE OUT SW jack to the line input on a powered subwoofer in Zone 2.
- Connect your Zone 2 speakers to the speaker terminals on your Zone 2 amp.

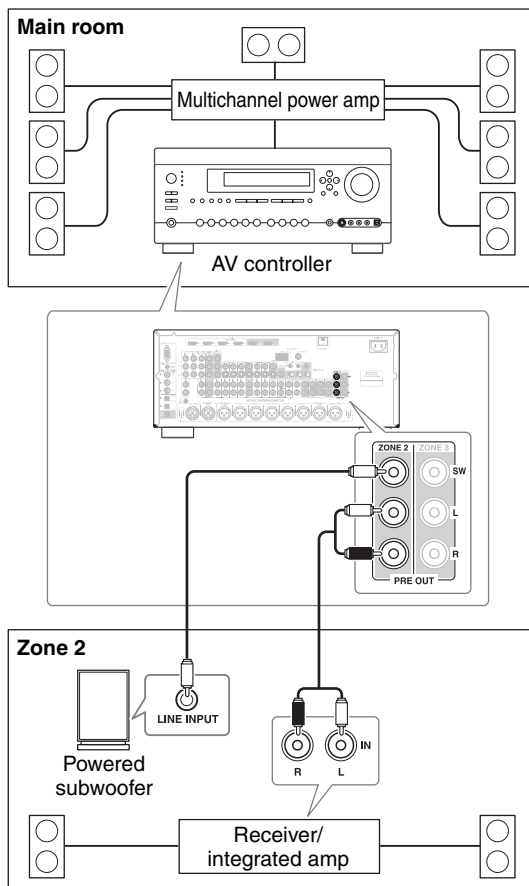

Note:

With the default settings, the Zone 2 volume must be set on the Zone 2 amp. If your Zone 2 amp has no volume control, set the "Zone2 Out" setting to "Variable" so that you can set the Zone 2 volume on the AV controller (see page 132).

Zone 2 Video Outputs

The AV controller features a composite video output and component video output for connection to a TV in Zone 2, so you can enjoy both audio and video in that zone.

Hookup

- Use a composite video cable to connect the AV controller's ZONE 2 OUT V jack to a composite video input on your Zone 2 TV.
- Alternatively, use a component video cable to connect the AV controller's COMPONENT VIDEO MONITOR OUT 2/ZONE 2 OUT jacks to a component video input on your Zone 2 TV.

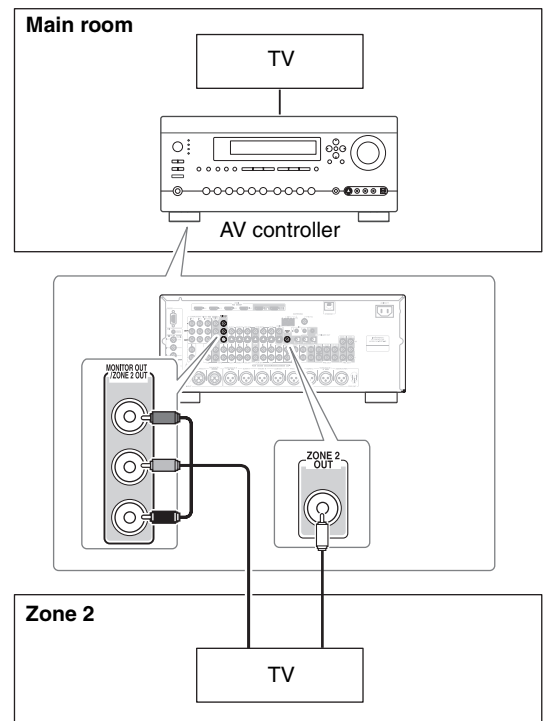

- If you use the COMPONENT VIDEO MONITOR OUT 2/ZONE 2 OUT, you must set the "Component Out2" setting to "Zone 2" (see page 50).

Notes:

- The ZONE 2 OUT V jack outputs video from components connected to composite video inputs and S-Video inputs.
- If you use the ZONE 2 OUT, you must set the "Component Out2" setting to "Zone 2" (see page 52). The ZONE 2 OUT outputs video only from components connected to component video inputs.

Connecting Zone 3

Zone 3 speakers must be connected to an amp in Zone 3.

Connecting Your Zone 3 Speakers

You can enjoy 2-channel stereo playback in Zone 3 and a different source to those selected for your main room and Zone 2.

Hookup

- Use an RCA audio cable to connect the AV controller's ZONE 3 PRE OUT L/R jacks to an analog audio input on your Zone 3 amp.
- Use an RCA audio cable to connect the AV controller's ZONE 3 PRE OUT SW jack to the line input on a powered subwoofer in Zone 3.
- Connect your Zone 3 speakers to the speaker terminals on your Zone 3 amp.

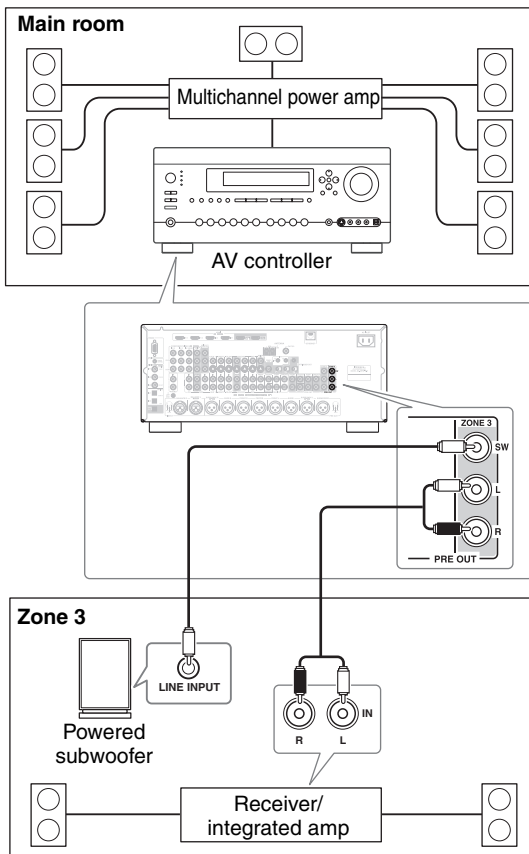

Note:

With the default settings, the Zone 3 volume must be set on the Zone 3 amp. If your Zone 3 amp has no volume control, set the “Zone3 Out” setting to “Variable” so that you can set the Zone 3 volume on the AV controller (see page 132).

Zone 2/Zone 3 Out Settings

If you've connected your Zone 2 or Zone 3 speakers to an amp with no volume control, set the "Zone2 Out" or "Zone3 Out" setting, respectively, to "Variable" so that you can set the zone's volume, balance, and tone on the AV controller.

1 Press the [Receiver] Remote Mode button, followed by the [Setup] button.
The main menu appears onscreen. If the main menu doesn't appear, make sure the appropriate external input is selected on your TV.



2 Use the Up and Down [▲]/[▼] buttons to select "7. Hardware Setup", and then press [Enter].
The "Hardware Setup" menu appears.



3 Use the Up and Down [▲]/[▼] buttons to select "2. Zone2/Zone3", and then press [Enter].
The "Zone2/Zone3" screen appears.



7-2. Zone2/Zone3		Integra
Zone2 Out	Fixed	
Zone3 Out	Fixed	

4 Use the Up and Down [▲]/[▼] buttons to select "Zone2 Out" or "Zone3 Out", and use the Left and Right [◀]/[▶] buttons to select:

Fixed:
The Zone 2 or Zone 3 volume must be set on the amp in that zone.

Variable:
The Zone 2 or Zone 3 volume can be set on the AV controller.



5 Press the [Setup] button.
Setup closes.





Note:
This procedure can also be performed on the AV controller by using its [Setup] button, arrow buttons, and [Enter] button.

Using Zone 2 and Zone 3

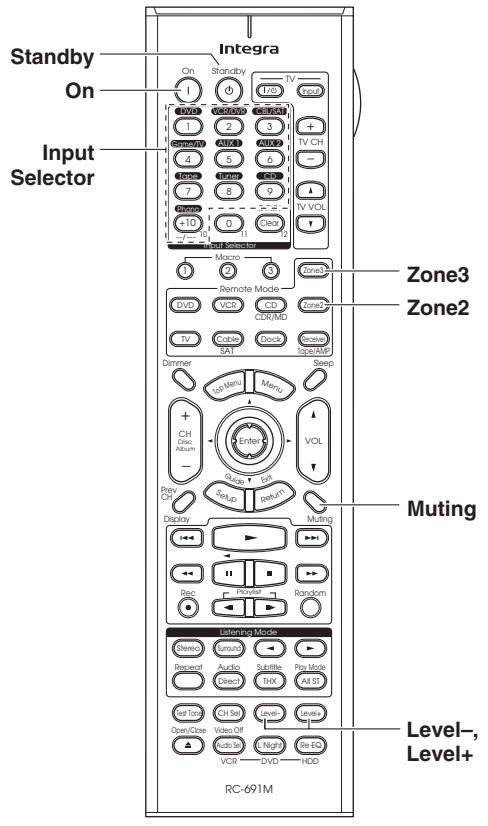
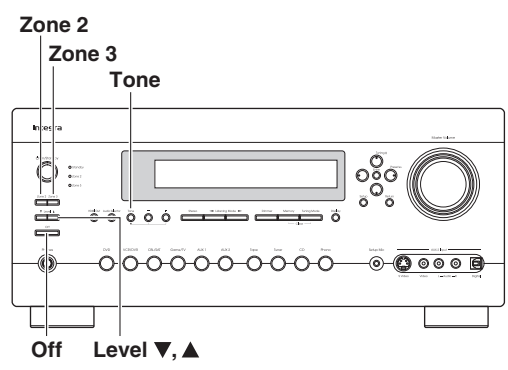
This section explains how to use Zone 2 and Zone 3.



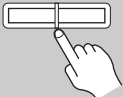

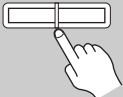
Selecting an Input Source for Zones

<p>1</p> <p>Remote controller</p>  <p>AV controller</p> <p>Zone 2 Zone 3</p> 	<p>On the remote controller, press the [Zone2] or [Zone 3] Remote Mode button.</p> <p>On the AV controller, press the [Zone 2] or [Zone 3] button.</p> <p>The Zone 2 or Zone 3 indicator flashes, and the input selector currently selected for the zone appears on the display.</p>
<p>2</p> <p>Remote controller</p>  <p>or</p> <p>AV controller</p> <p>Zone 2 Zone 3</p> 	<p>On the remote controller, use the Input Selector buttons.</p> <p>On the AV controller, use the input selector buttons, or press the [Zone 2] or [Zone 3] button repeatedly.</p> <p>The input source is selected, the zone is turned on, the name of the input selector appears on the display, and the Zone 2 or Zone 3 indicator lights continuously.</p> <p>You can also use the AV controller's Input Selector buttons.</p>



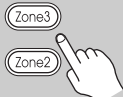
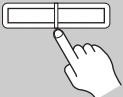

Notes:

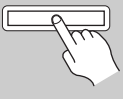
- To select AM or FM, press the [Tuner] input selector button repeatedly. On the North American model, you can also select XM or SIRIUS.
- Only analog input sources are output by the ZONE 2 PRE OUT, and ZONE 3 PRE OUT. Digital input sources are not output. If no sound is heard when an input source is selected, check if it's connected to an analog input.
- While Zone 2 or Zone 3 is on, the Auto Power On/ Standby and Direct Change **RI** functions do not work.
- You cannot select different AM or FM radio stations for your main room, Zone 2, and Zone 3. The same AM/FM radio station will be heard in each room.
- On the North American model, you can select a different radio source for each room. For example, XM for your main room, SIRIUS for Zone 2, and AM/FM for Zone 3.

Turning Off Zones

<p>1</p> <p>Remote controller</p>  <p>AV controller</p> <p>Zone 2 Zone 3</p> 	<p>On the remote controller, press the [Zone2] or [Zone 3] Remote Mode button.</p> <p>On the AV controller, press the [Zone 2] or [Zone 3] button.</p> <p>The Zone 2 or Zone 3 indicator flashes.</p>
<p>2</p> <p>Remote controller</p> <p>Standby</p>  <p>AV controller</p> <p>Off</p> 	<p>On the remote controller, press the [Standby] button.</p> <p>On the AV controller, press the [Off] button.</p> <p>The zone is turned off, and the Zone 2 or Zone 3 indicator goes off.</p>



Adjusting the Volume of Zones

<p>1</p>  <p>Remote controller</p>  <p>AV controller Zone 2 Zone 3</p>	<p>On the remote controller, press the [Zone2] or [Zone 3] Remote Mode button.</p> <p>On the AV controller, press the [Zone 2] or [Zone 3] button.</p> <p>The Zone 2 or Zone 3 indicator flashes.</p>
<p>2</p>  <p>Remote controller</p>  <p>AV controller Level</p>	<p>On the remote controller, press the [Level-] and [Level+] button.</p> <p>On the AV controller, press Up [▲] and Down [▼] button.</p>

Note:

Zones can also be unmuted by adjusting the volume.

Muting Zones

 <p>Zone3 Zone2</p>  <p>Muting</p>	<p>On the remote controller, press the [Zone2] or [Zone 3] Remote Mode button, and then press the [Muting] button.</p> <p>To unmute a zone, on the remote controller, press the [Zone2] or [Zone 3] Remote Mode button, and then press the [Muting] button again.</p>
--	---

Adjusting the Tone and Balance of Zones

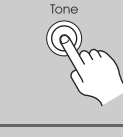
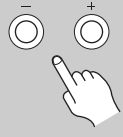
<p>1</p>  <p>AV controller Zone 2 Zone 3</p>	<p>On the AV controller, press the [Zone 2] or [Zone 3] button.</p>
<p>2</p>  <p>Tone</p>	<p>Press the AV controller's [Tone] button repeatedly to select "Bass" "Treble" or "Balance".</p>
<p>3</p>  <p>- +</p>	<p>Use the Tone Plus [+] and Minus [-] buttons to adjust the Bass, Treble or Balance.</p> <ul style="list-style-type: none"> You can boost or cut the Bass or Treble from -10 dB to +10 dB in 2 dB steps. You can adjust the balance from 0 in the center to +10 dB to the right or -10 dB to the left in 2 dB steps.

Notes:

- The tone cannot be adjusted for Zone 3.
- The Zone 2 level, balance, and tone functions have no effect on the ZONE 2 PRE OUT when the "Zone2 Out" setting is set to "Fixed" (page 132).
- The Zone 3 level and balance functions have no effect on the ZONE 3 PRE OUT when the "Zone3 Out" setting is set to "Fixed" (page 132).

Using the 12V Triggers

The 12V triggers A, B, and C can be used to turn on 12V trigger-capable components automatically when they are selected as the input source. The triggers can be set so that they activate when a connected component is selected as the input source for the main room, Zone 2, Zone 3, or any combination of rooms.

When triggered, the output from a 12V TRIGGER OUT goes high (+12 volts, 100 milliamperes max).

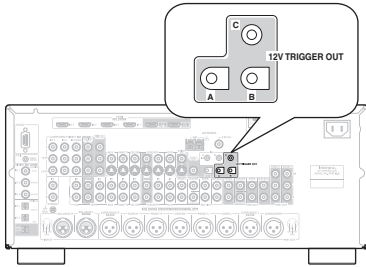

Hookup

- Use a miniplug cable to connect the AV controller's 12V TRIGGER OUT A, B, or C jack to the 12 V trigger input on a connected component.

When several components are turned on simultaneously by using triggers A, B, and C, depending on the type of components, a large amount of current may be drawn momentarily. To prevent this, you can delay trigger signals A, B, and C individually. Another application for trigger delay is eliminating the “thump” noise that’s sometimes heard when a source component is turned on. Delaying the trigger signal for your power amplifier so that it’s the last component to be turned on will accomplish this.

1

Press the [Receiver] Remote Mode button, followed by the [Setup] button.

The main menu appears onscreen. If the main menu doesn't appear, make sure the appropriate external input is selected on your TV.



2

Use the Up and Down [▲]/[▼] buttons to select “6. Miscellaneous,” and then press [Enter].

The “Miscellaneous” menu appears.

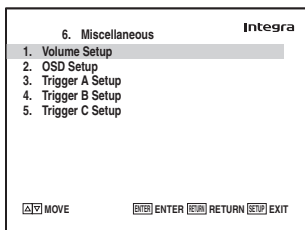

3

Use the Up and Down [▲]/[▼] buttons to select “12V Trigger A, B, or C,” and then press [Enter].

The “12V Trigger A/B/C Setup” screen appears.

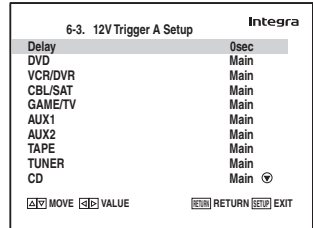
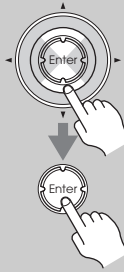

4

Use the Up and Down [▲]/[▼] buttons to select “Delay,” and use the Left and Right [◀]/[▶] buttons to select: 0 sec, 1 sec, 2 sec, or 3 sec.

When 0 sec is selected, the trigger signal is output as soon as the input source is changed.



5

Use the Up and Down [▲]/[▼] buttons to select an input source, and use the Left and Right [◀]/[▶] buttons to select an option.

Off:
No trigger signal is output. A 12-volt trigger signal is output when the connected component is selected as the source for:

- Main:** Main room.
- Zone2:** Zone 2.
- Main/Z2:** Main room or Zone 2.
- Zone3:** Zone 3.
- Main/Z3:** Main room or Zone 3.
- Z2/Z3:** Zone 2 or Zone 3.
- Main/Z2/Z3:** Main room, Zone 2, or Zone 3.



6

When you've finished, press the [Setup] button.

Setup closes.



Using the Remote Controller in Zone 2/3 and Multiroom Control Kits

To control the AV controller with the remote controller while you're in Zone 2 or Zone 3, you'll need a commercially available multiroom remote control kit for each zone.

- Multiroom kits are made by Niles and Xantech.

These kits can also be used when there isn't a clear line of sight to the AV controller's remote sensor, such as when it's installed inside a cabinet.

Using a Multiroom Kit with Zone 2/3

In this setup, the IR receiver in Zone 2/3 picks up the infrared signals from the remote controller and feeds them through to the AV controller in the main room via the connecting block.

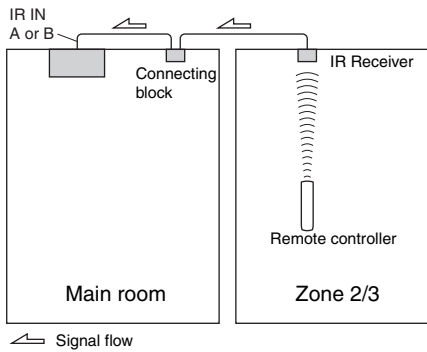

The miniplug cable from the connecting block should be connected to the AV controller's IR IN A or B jack, as shown below. The IR IN A and B jacks are identical. Up to two IR receivers can be connected.

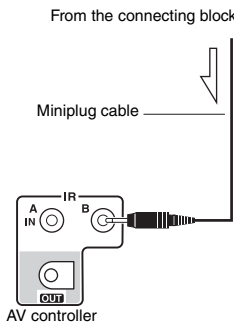

Using a Multiroom Kit with a Cabinet

In this setup, the IR receiver picks up the infrared signals from the remote controller and feeds them to the AV controller located in the cabinet via the connecting block.

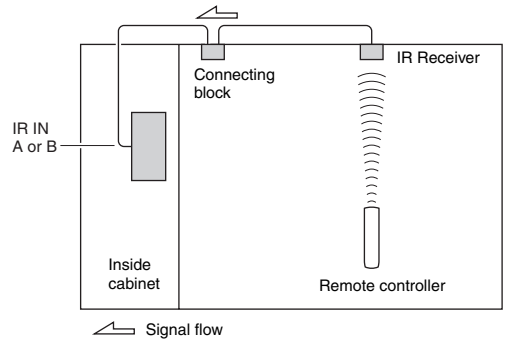

Using a Multiroom Kit with Other Components

In this setup, an IR emitter is connected to the AV controller's IR OUT jack and placed in front of the other component's remote control sensor. Infrared signals received at the AV controller's IR IN A or B jack are fed through to the other component via the IR emitter. Signals picked up by the AV controller's remote control sensor are not output.

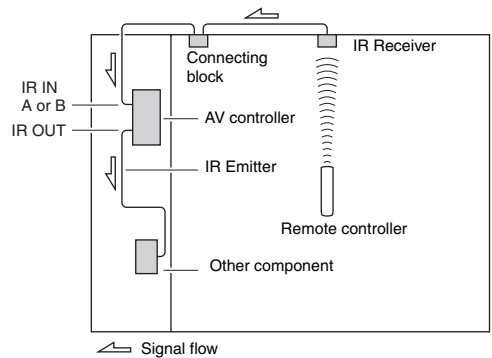

The IR emitter should be connected to the AV controller's IR OUT jack, as shown below.

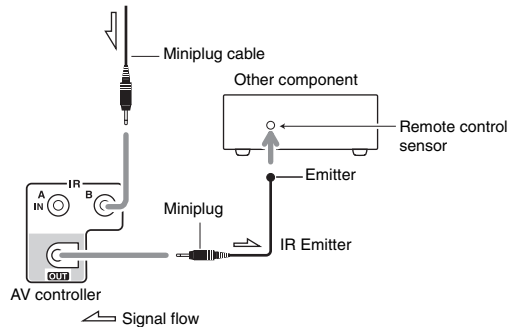

Controlling Other Components

You can control your other components, including those made by other manufacturers, with the remote controller. This section explains how to:

- Enter the remote control code for a component that you want to control: DVD, TV, VCR, etc.
- Learn commands directly from another component's remote controller (see page 140).
- Program the Macro buttons to perform a sequence of up to eight remote control actions (see page 141).

Entering Remote Control Codes

To control another component, you must first enter that component's remote control code to a Remote Mode button. You'll need to enter a code for each component that you want to control.

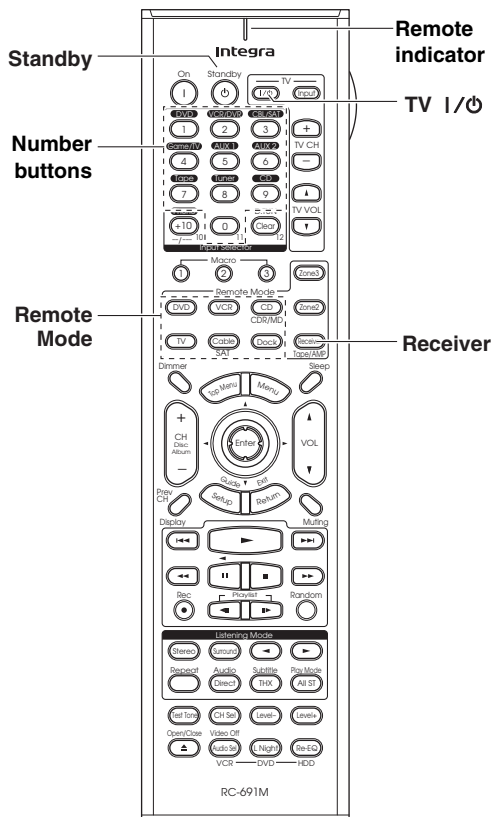

1 Look up the component's remote control code in the separate Remote Control Codes list. The codes are organized by category.

2 While holding down the Remote Mode button to which you want to enter the code, press the [Standby] button.

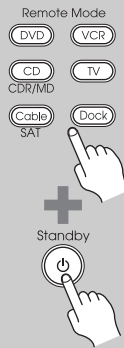

The Remote indicator lights up.

3 Within 30 seconds, use the number buttons to enter the 4-digit remote control code.



The Remote indicator flashes twice.

4 Press the Remote Mode button again to select the remote controller mode, point the remote controller at the component, and check the operation.

If the remote controller doesn't work as expected, and several remote codes are listed, try each one in turn and use the one that works best.

Notes:

- Remote control codes cannot be entered for the [Receiver], [Zone 2], and [Zone 3] Remote Mode buttons.
- The remote control codes provided are correct at the time of printing but subject to change.

- The [DVD] and [CD] Remote Mode buttons are preprogrammed for use with Integra/Onkyo DVD players and CD players, respectively.
- To control another manufacturer's CD recorder, MD recorder or Onkyo RI Dock, enter the appropriate remote control code to the [CD] Remote Mode button.

Remote Control Codes for Integra/Onkyo Components Connected via RI

Integra/Onkyo components that are connected via **RI** are controlled by pointing the remote controller at the AV controller, not the component. This allows you to control components that are out of view, in a rack, for example.

1 Make sure the Integra/Onkyo component is connected with an **RI** cable and an analog audio cable (RCA).

See page 44 for details.

2 Enter the appropriate remote control code to the Remote Mode button.

- [DVD] Remote Mode button
5002: Integra/Onkyo DVD player with **RI**
- [CD] Remote Mode button
6002: Integra/Onkyo CD player with **RI**
- [MD] Remote Mode button
6008: Onkyo MD recorder with **RI**
- [CDR] Remote Mode button
6006: Onkyo CD recorder with **RI**
- [Dock] Remote Mode button
6004: Onkyo RI Dock with **RI**

See the previous page for how to enter remote control codes.

3 Press the Remote Mode button, point the remote controller at the AV controller, and operate the component.

If you want to control an Integra/Onkyo component by pointing the remote controller directly at it, or you want to control an Integra/Onkyo component that's not connected via **RI**, use the following remote control codes:

- [DVD] Remote Mode button
5001: Integra/Onkyo DVD player without **RI** (default)
- [CD] Remote Mode button
6001: Integra/Onkyo CD player without **RI** (default)
- [MD] Remote Mode button
6007: Onkyo MD recorder without **RI**
- [CDR] Remote Mode button
6005: Onkyo CD recorder without **RI**
- [Dock] Remote Mode button
6003: Onkyo RI Dock without **RI**

Note:

If you connect an **RI**-capable Onkyo MiniDisc recorder, CD recorder, or RI Dock to the TAPE IN/OUT jacks, or connect an RI Dock to the AUX 1 jacks, for **RI** to work properly, you must set the Input Display accordingly (see page 57).

Resetting the Remote Mode Buttons

You can reset a Remote Mode button to its default remote control code.

1 While holding down the Remote Mode button that you want to reset, press the TV [I/⏻] button. The Remote indicator flashes three times.

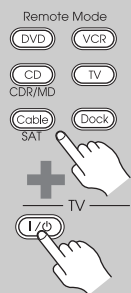

2 Press the Remote Mode button again. The Remote indicator flashes twice, indicating that the button has been reset. The [DVD] and [CD] Remote Mode buttons are preprogrammed with remote control codes for controlling Onkyo DVD players and CD players, respectively. When these buttons are reset, the preprogrammed codes are restored.

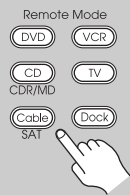

Resetting the Remote Controller

You can reset the remote controller to its default settings.

1 While holding down the [Receiver] Remote Mode button, press the [Standby] button. The Remote indicator flashes five times.



2 Press the [Receiver] Remote Mode button again. The Remote indicator flashes twice, indicating that the remote controller has been reset.



Controlling Other Components—Continued

To control another component, point the remote controller at it and use the buttons explained below. (You must select the appropriate remote controller mode with the Remote Mode buttons first.) With some components, certain buttons may not work as expected, and some may not work at all.

■ Controlling a TV

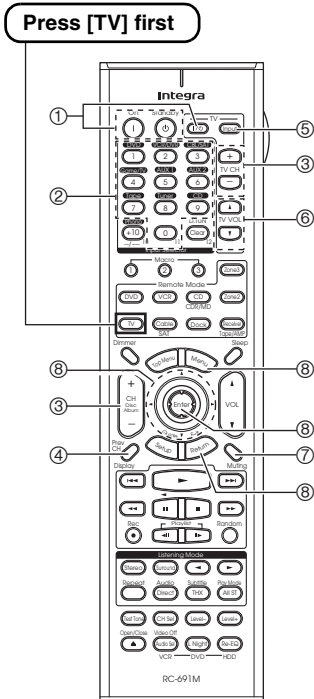

- ① **[On], [Standby], TV [I/⏻]***
Set the TV to On or Standby.
- ② **Number buttons**
Enter numbers.
- ③ **[CH +/-], TV CH [+]/[-]***
Select channels on the TV.
- ④ **[Prev CH]**
Selects the previous channel.
- ⑤ **[TV Input]***
Selects the TV's external inputs.
- ⑥ **TV VOL [▲]/[▼]***
Adjust the TV's volume.
- ⑦ **[Muting]**
Mutes the TV.
- ⑧ **[▲]/[▼]/[◀]/[▶]/[Menu]/[Enter]/[Return]**
Navigate menus on the TV.

Buttons marked with an asterisk () are exclusively for controlling a TV and can be used at any time, regardless of the currently selected remote controller mode.

■ Controlling a VCR

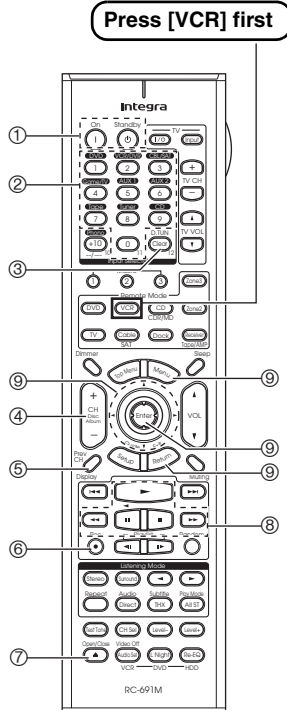

- ① **[On], [Standby]**
Set the VCR to On or Standby.
- ② **Number buttons**
Enter numbers.
- ③ **[Clear]**
Cancels functions.
- ④ **[CH +/-]**
Selects channels on the VCR.
- ⑤ **[Prev CH]**
Selects the previous channel.
- ⑥ **Rec [●]**
Starts recording.
- ⑦ **Eject [▲]**
Ejects the videocassette.
- ⑧ **[▶], [⏸], [■], [◀◀], [▶▶]**
Play, Pause, Stop, Rewind, and Fast forward.
- ⑨ **[▲]/[▼]/[◀]/[▶]/[Menu]/[Enter]/[Return]**
Navigate menus on the VCR.

■ Controlling a Satellite or Cable Receiver

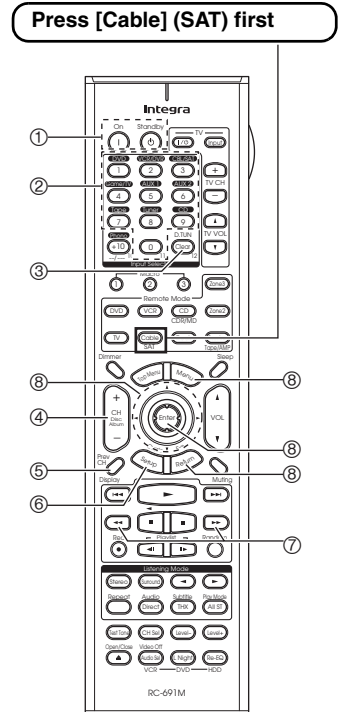

- ① **[On], [Standby]**
Set the satellite/cable receiver to On or Standby.
- ② **Number buttons**
Enter numbers.
- ③ **[Clear]**
Cancels functions.
- ④ **[CH +/-]**
Selects satellite/cable channels.
- ⑤ **[Prev CH]**
Selects the previous channel.
- ⑥ **[Guide]**
Displays the program guide.
- ⑦ **[◀◀], [▶▶]**
Fast Reverse and Fast forward.
- ⑧ **[▲]/[▼]/[◀]/[▶]/[Menu]/[Enter]/[Return]**
Navigate menus on the satellite/cable receiver.

Learning Commands

The AV controller's remote controller can learn the commands of other remote controllers. By transmitting, for example, the Play command from your CD player's remote controller, the remote controller can learn it, and then transmit the exact same command when its Play [▶] button is pressed in the CD remote mode.

This is useful when you've entered the appropriate remote control code (page 137) but some buttons don't work as expected.

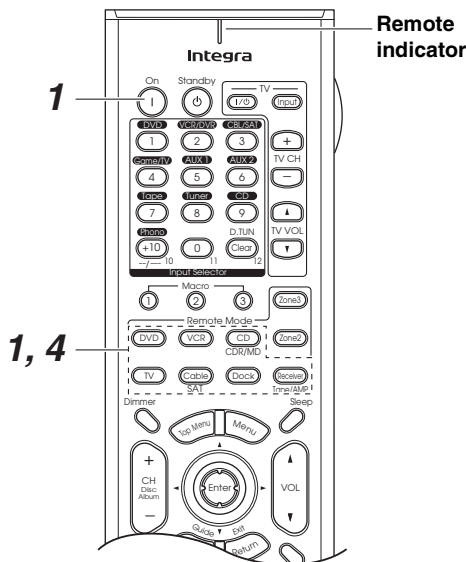

1 While holding down the Remote Mode button for the mode in which you want to use the command, press the [On] button. The Remote indicator lights up.

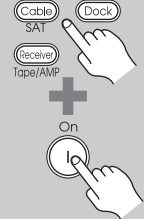

2 Press the button you want to learn the new command.

3 Point the remote controllers at each other, about 2 to 6 inches (5–15 cm) apart, and then press and hold the button whose command you want to learn until the Remote indicator flashes.

If the command is learned successfully, the Remote indicator flashes twice.

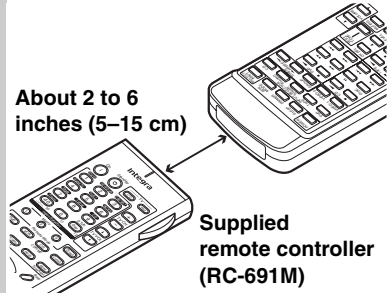

4 To learn more commands, repeat steps 2 and 3. Press any Remote Mode button when you've finished.

Notes:

- The following buttons cannot learn new commands: Remote Mode, Macro [1], [2], [3], TV CH [+]/[-], Re-EQ, Light.
- When you want to learn the command from your TV's Power button, select the TV remote control mode and use the remote controller's [Standby] button to learn the command. In the TV remote control mode, the remote controller's [Standby] and TV [I/⏻] buttons are linked, so using the [Standby] button to learn the command will mean that you can also use the TV [I/⏻] button to turn your TV on or off in TV remote control mode.
- When you want to learn the commands from your TV's Channel Up and Down buttons, select the TV remote control mode and use the remote controller's CH [+/-] button (left to the [Enter] button) to learn the commands. In the TV remote control mode, the remote controller's CH [+/-] and TV CH [+]/[-] buttons are linked, so using the CH [+/-] button to learn these commands will mean that you can also use the TV CH [+]/[-] buttons to change channels in TV remote control mode.
- The remote controller can learn approximately 70 to 90 commands, although this will be less if commands that use a lot of memory are learned.
- Remote controller buttons such as Play, Stop, Pause, and so on are preprogrammed with commands for controlling Integra/Onkyo CD players, cassette decks, and DVD players. However, they can learn new commands, and you can restore the preprogrammed commands at any time by resetting the remote controller (see page 138).
- To overwrite a previously learned command, repeat this procedure.
- Only commands from infrared remote controllers can be learned.
- When the remote controller's batteries expire, all learned commands will be lost and will have to be learned all over again, so don't discard your other remote controllers.

Using Macros

You can program the remote controller's Macro buttons to perform a sequence of remote control actions.

Example:

To play a CD you typically need to perform the following actions:

1. Press the [Receiver] Remote Mode button to select the Receiver remote controller mode.
2. Press the [On] button to turn on the AV controller.
3. Press the [CD] Input Selector button to select the CD input source.
4. Press the [CD] Remote Mode button to select the CD remote controller mode.
5. Press the Play [▶] button to start playback on the CD player.

You can program a Macro button so that all five actions are performed with just one button press.

Making Macros

Each Macro button can store one macro, and each macro can contain up to eight commands.

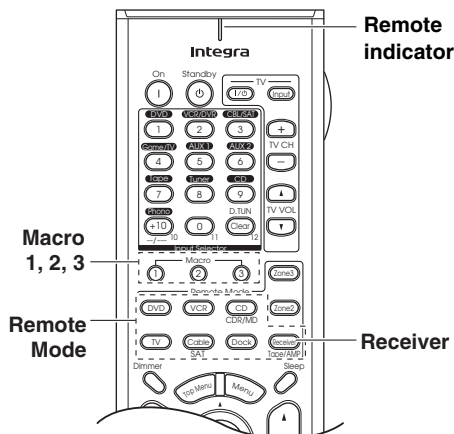

1 While holding down the Remote Mode button of the remote controller mode you want to use at the start of the macro, press Macro button [1], [2], or [3].

The Remote indicator lights up.

For the CD example in the left column, you'd press and hold the [Receiver] Remote Mode button, and then press Macro button [1], [2], or [3].

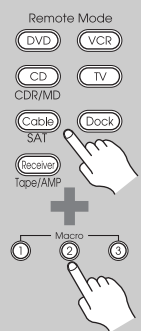

2

Press the buttons whose actions you want to program into the macro in the order you want them performed.

For the CD example in the left column, you'd press the following buttons: [On], [CD] Input Selector, [CD] Remote Mode, Play [▶].

3

When you've finished, press the Macro button again.

The Remote indicator flashes twice. If you enter eight commands, the process will finish automatically.

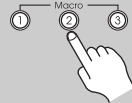

Note:

If any of the buttons you used to make a macro are taught new commands, the macro will no longer work properly and will have to be made again.

Running Macros



Press the Macro [1], [2], or [3] button.

The commands in the macro are transmitted in the order in which they were programmed. Keep the remote controller pointed at the AV controller until all of the commands have been transmitted.

Macros can be run at any time, regardless of the current remote controller mode.

Deleting Macros

1

While holding down the [Receiver] Remote Mode button, press the Macro button whose macro you want to delete.

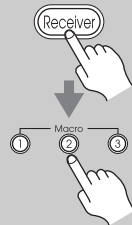

2

Press the Macro button again.

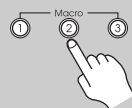

Troubleshooting

If you have any trouble using the AV controller, look for a solution in this section. If you can't resolve the issue yourself, contact the dealer from whom you purchased this unit.

If you can't resolve the issue yourself, try resetting the AV controller before contacting the dealer from whom you purchased this unit.

To reset the AV controller to its factory defaults, turn it on and, while holding down the [VCR/DVR] button, press the [On/Standby] button. "Clear" will appear on the display and the AV controller will enter Standby mode.

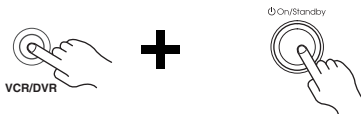

Note that resetting the AV controller will delete your radio presets and custom settings.

Power

Can't turn on the AV controller

- Make sure that the power cord is properly plugged into the wall outlet.
- Unplug the power cord from the wall outlet, wait 5 seconds or more, then plug it in again.

Audio

There's no sound or it's very quiet

- Make sure that your multichannel power amplifier is turned on and set up correctly and connected to the AV controller properly (page 21).
- Make sure that the digital input source is selected properly (page 53).
- Make sure that the correct audio input is selected (page 129).
- Make sure that all audio connecting plugs are pushed in all the way (page 28).
- Check the volume. It can be set to $-\infty$ dB, -81.5 dB through $+18.0$ dB (page 64). The AV controller is designed for home theater enjoyment. It has a wide volume range, allowing precise adjustment.
- If the MUTING indicator is flashing on the display, press the remote controller's [Muting] button to unmute the AV controller (page 65).
- While a pair of headphones is connected to the Phones jack, no sound is output by the speakers (page 66).
- Check the digital audio output setting on the connected device. On some game consoles, such as those that support DVD, the default setting is off.
- With some DVD-Video discs, you need to select an audio output format from a menu.
- If your turntable uses an MC cartridge, you must use an MC head amp or MC transformer (page 41).
- Check the speaker settings (pages 104–110).

- The input signal format is set to PCM or DTS. Set it to "Auto" (page 129).
- If there's no sound from a DVD player connected to an HDMI IN, check the DVD player's output settings, and be sure to select a supported audio format.
- Make sure that none of the connecting cables are bent, twisted, or damaged.

Only the front speakers produce sound

- When the Stereo listening mode is selected, only the front speakers and subwoofer produce sound.
- In the Mono listening mode, only the front speakers output sound if the "Output Speaker" setting is set to "L/R" (page 114).
- Check the Speaker Configuration (page 104).

Only the center speaker produces sound

- If you use the Dolby Pro Logic IIX Movie, Dolby Pro Logic IIX Music, or Dolby Pro Logic IIX Game listening mode with a mono source, such as an AM radio station or mono TV program, the sound is concentrated in the center speaker.
- In the Mono listening mode, only the front speakers output sound if the "Output Speaker" setting is set to "C" (page 114).
- Check the Speaker Configuration (page 104).

The surround speakers produce no sound

- When the Stereo or Mono listening mode is selected, the surround speakers produce no sound.
- Depending on the source and the current listening mode, not much sound may be produced by the surround speakers. Try another listening mode (page 90).
- Make sure the speakers are configured correctly (page 104).

The center speaker produces no sound

- When the Stereo listening mode is selected, the center speaker produces no sound.
- In the Mono listening mode, only the front speakers output sound if the "Output Speaker" setting is set to "L/R" (page 114).
- Make sure the speakers are configured correctly (page 104).

The surround back speakers produce no sound

- The surround back speakers are not used with all listening modes. Select another listening mode (page 90).
- Not much sound may be produced by the surround back speakers with some sources.
- Make sure the speakers are configured correctly (page 104).

The subwoofer produces no sound

- When you play source material that contains no information in the LFE channel, the subwoofer produces no sound.
- Make sure the speakers are configured correctly (page 104).

The Zone 2/3 speakers produce no sound

- The Zone 2/3 speakers only output sources that are connected to an analog input. Check to see if the source component is connected to an analog input.

There's no sound with a certain signal format

- Check the digital audio output setting on the source component. On some game consoles, such as those that can play DVDs, the default setting is off.
- With some DVD-Video discs, you need to select an audio format from a menu or with the [Audio] button on your DVD player's remote controller.
- Depending on the input signal, some listening modes cannot be selected (pages 91-96).

The volume cannot be set as required (The volume cannot be set to +18.0 dB)

- Check to see if a maximum volume has been set (page 123).
- After the Automatic Speaker Setup function has been run, or the volume level of each individual speaker has been adjusted (pages 65 and 108), the maximum volume may be reduced.

Noise can be heard

- Using cable ties to bundle audio cables with power cords, speaker cables, and so on can degrade audio performance, so don't use them.
- An audio cable may be picking up interference. Try repositioning your cables.

The Late Night function doesn't work

- Make sure the source material is Dolby Digital, Dolby Digital Plus, and Dolby TrueHD (page 117).

The DVD analog multichannel input doesn't work

- Check the DVD multichannel input connections (page 33).
- Make sure that the multichannel input is assigned to the input selector (page 54).
- Make sure that the multichannel input is selected (page 129).
- Make sure that the "Speaker Type" is not set to "Bi-Amp". The multichannel DVD input cannot be used if "Speaker Type" is set to "Bi-Amp" (page 55).
- Check the audio output settings on your DVD player.

About DTS signals

- When DTS program material ends and the DTS bitstream stops, the AV controller remains in DTS listening mode and the DTS indicator remains on. This is to prevent noise when you use the pause, fast forward, or fast reverse function on your player. If you switch your player from DTS to PCM, because the AV controller does not switch formats immediately, you may not hear any sound, in which case you should stop your player for about three seconds, and then resume playback.
- With some CD players, you won't be able to playback DTS material properly even though your player is connected to a digital input on the AV controller. This is usually because the DTS bitstream has been processed (e.g., output level, sampling rate, or frequency response changed) and the AV controller doesn't recognize it as a genuine DTS signal. In such cases, you may hear noise.

- When playing DTS program material, using the pause, fast forward, or fast reverse function on your player may produce a short audible noise. This is not a malfunction.

The beginning of audio received by an HDMI IN can't be heard

- Since it takes longer to identify the format of an HDMI signal than it does for other digital audio signals, sound may not be output immediately.

Video

There's no picture

- Make sure that all video connecting plugs are pushed in all the way (page 28).
- Make sure that each video component is properly connected (pages 31-43).
- On your TV, make sure that the video input to which the AV controller is connected is selected.
- If your TV is connected to the HDMI output, set the "Monitor Out" setting to "HDMI Main" or "HDMI Sub" (page 46), and select "--" in the "Video Input Setup" on page 50 to watch composite video, S-Video, and component video sources.
- If your TV is connected to the COMPONENT VIDEO MONITOR OUT 1 or 2, set the "Monitor Out" setting to "Analog" (page 49), and select "--" in the "Component Video Setup" on page 52 to watch composite video and S-Video sources.
- If the video source is connected to a component video input, you must assign that input to an input selector (page 52), and your TV must be connected to either the HDMI OUT or COMPONENT VIDEO MONITOR OUT 1 or 2 (pages 31 and 37).
- If the video source is connected to an HDMI input, you must assign that input to an input selector (page 50), and your TV must be connected to the HDMI OUT (page 37).

There's no picture from a source connected to an HDMI IN

- When the "Monitor Out" setting is set to "Analog", and the "Resolution" setting is set to anything other than "Through" (see page 50), no video is output by the HDMI OUT.
- If the message "Resolution Error" appears on the AV controller's display, this indicates that your TV does not support the current video resolution and you need to select another resolution on your DVD player.

The onscreen menus don't appear

- If your TV is connected to the analog outputs, set the "Monitor Out" setting to "Analog" (page 46).
- On your TV, make sure that the video input to which the AV controller is connected is selected.
- On non-North American models, specify the TV system used in your area in the "TV Format Setup (not North American models)" on page 56.

The immediate display does not appear

- The immediate display will not appear when the input signal from the COMPONENT VIDEO IN is output to a device connected to the COMPONENT VIDEO MONITOR OUT.
- Depending on the input signal, the immediate display may not appear when the input signal from the HDMI IN is output to a device connected to the HDMI OUT.

Tuner

Reception is noisy, FM stereo reception is noisy, or the FM STEREO indicator doesn't appear

- Relocate your antenna.
- Move the AV controller away from your TV or computer.
- Listen to the station in mono (page 67).
- When listening to an AM station, operating the remote controller may cause noise.
- Passing cars and airplanes can cause interference.
- Concrete walls weaken radio signals.
- If nothing improves the reception, install an outdoor antenna.

Remote Controller

The remote controller doesn't work

- Make sure that the batteries are installed with the correct polarity (page 15).
- Make sure that the remote controller is not too far away from the AV controller, and that there's no obstruction between the remote controller and the AV controller's remote control sensor (page 15).
- Make sure you've selected the correct remote controller mode (page 16).
- Make sure you've entered the correct remote control code (page 137).
- Install new batteries. Don't mix different types of batteries, or old and new batteries (page 15).
- Make sure that the AV controller is not subjected to direct sunshine or inverter-type fluorescent lights. Relocate if necessary.
- If the AV controller is installed in a rack or cabinet with colored-glass doors, the remote controller may not work reliably when the doors are closed.
- When using the remote controller to control other manufacturers' AV components, some buttons may not work as expected.
- Make sure to set the same ID on both the AV controller and remote controller (page 125).

Can't control other components

- If it's an Onkyo component, make sure that the **RI** cable and analog audio cable are connected properly. Connecting only an **RI** cable won't work (page 44).
- Make sure you've selected the correct remote controller mode (page 16).

- If you've connected an **RI**-capable Onkyo MD recorder, CD recorder, **RI** Dock to the TAPE IN/OUT jacks, or an **RI** Dock to the AUX 1 jacks, for the remote controller to work properly, you must set the display to MD, CDR, or DOCK (page 57).
If you cannot operate it, you will need to enter the appropriate remote control code (page 137).
- The entered remote control code may not be correct. If more than one code is listed, try each one.
- If none of the codes work, use the Learning function to learn the commands of the other component's remote controller (page 140).
- With some AV components, certain buttons may not work as expected, and some may not work at all.
- To control an Integra/Onkyo component that's connected via **RI**, point the remote controller at the AV controller. Be sure to enter the appropriate remote control code first (page 138).
- To control an Integra/Onkyo component that's not connected via **RI**, or another manufacturer's component, point the remote controller at that component. Be sure to enter the appropriate remote control code first (page 137).

Can't learn commands from another remote controller

- When learning commands, make sure that the transmitting ends of both remote controllers are pointing at each other.
- Are you trying to learn from a remote controller that cannot be used for learning? Some commands cannot be learned, especially those that contain several instructions.

Recording

Can't record

- On your recorder, make sure the correct input is selected.
- To prevent signal loops and damage to the AV controller, input signals are not fed through to outputs with the same name (e.g., TAPE IN to TAPE OUT or VCR/DVR IN to VCR/DVR OUT).

Zone 2/Zone 3

There's no sound

- Only components connected to analog inputs can be played in Zone 2 and Zone 3.

Others

The sound changes when I connect my headphones

- When a pair of headphones is connected, the listening mode is set to Stereo, unless it's already set to Stereo, Mono, or Direct.

The speaker volume cannot be set as required

- When the Automatic Speaker Setup function is used, or the volume is adjusted on the onscreen setup menus, the maximum possible volume setting may change.

The speaker distance cannot be set as required

- In some cases, corrected values suitable for home theater use may be set automatically.

How do I change the language of a multiplex source

- On the “Audio Adjust” menu, change the “Multiplex” setting to “Main” or “Sub” (page 114).

The **RI** functions don't work

- To use **RI**, you must make an **RI** connection and an analog audio connection (RCA) between the component and AV controller, even if they are connected digitally (page 44).
- While Zone 2 or Zone 3 is selected, the **RI** functions don't work.

The functions Auto Power On/Standby and Direct Change don't work for components connected via **RI**

- These functions don't work when Zone 2 is turned on.

When performing “Automatic Speaker Setup”, the measurement fails showing the message “Ambient noise is too high”.

- This can be caused by any malfunction in your speaker unit. Check if the unit produces normal sounds.

The AV controller contains a microcomputer for signal processing and control functions. In very rare situations, severe interference, noise from an external source, or static electricity may cause it to lockup. In the unlikely event that this happens, unplug the power cord from the wall outlet, wait at least 5 seconds, and then plug it back in again.

Onkyo is not responsible for damages (such as CD rental fees) due to unsuccessful recordings caused by this unit's malfunction. Before you record important data, make sure that the material will be recorded correctly.

For North American model, set the AV controller to Standby before disconnecting the power cord from the wall outlet. For other models, set the AV controller to Standby and the POWER switch to OFF before disconnecting the power cord.

Video Resolution Chart

The following tables show how video signals at different resolutions are output by the AV controller.

✓: Output

NTSC

Output Input		HDMI*1					COMPONENT				S-VIDEO	COMPOSITE
		1080p	1080i	720p	480p	480i	1080i	720p	480p	480i	480i	480i
HDMI	1080p	✓	✓	✓	✓							
	1080i	✓	✓	✓	✓							
	720p	✓	✓	✓	✓							
	480p	✓	✓	✓	✓							
	480i	✓	✓	✓	✓	✓						
COMPONENT	1080i	✓	✓	✓	✓		✓	✓	✓			
	720p	✓	✓	✓	✓		✓	✓	✓			
	480p	✓	✓	✓	✓		✓*2	✓*2	✓			
	480i	✓	✓	✓	✓	✓	✓*2	✓*2	✓	✓		
S-VIDEO	480i	✓	✓	✓	✓	✓	✓*2	✓*2	✓	✓	✓	✓
COMPOSITE	480i	✓	✓	✓	✓	✓	✓*2	✓*2	✓	✓	✓	✓

PAL

Output Input		HDMI*1					COMPONENT				S-VIDEO	COMPOSITE
		1080p	1080i	720p	576p	576i	1080i	720p	576p	576i	576i	576i
HDMI	1080p	✓	✓	✓	✓							
	1080i	✓	✓	✓	✓							
	720p	✓	✓	✓	✓							
	576p	✓	✓	✓	✓							
	576i	✓	✓	✓	✓	✓						
COMPONENT	1080i	✓	✓	✓	✓		✓	✓	✓			
	720p	✓	✓	✓	✓		✓	✓	✓			
	576p	✓	✓	✓	✓		✓*2	✓*2	✓			
	576i	✓	✓	✓	✓	✓	✓*2	✓*2	✓	✓		
S-VIDEO	576i	✓	✓	✓	✓	✓	✓*2	✓*2	✓	✓	✓	✓
COMPOSITE	576i	✓	✓	✓	✓	✓	✓*2	✓*2	✓	✓	✓	✓

*1 The video signal is output only when the “Monitor Out” setting is set to “HDMI Main” or “HDMI Sub”.

*2 The output is limited to 480p for an effective signal in the effect of Macrovision.

■ : The video signal is output only when the “Monitor Out” setting is set to “Analog”.

■ : The video signal will be output only when the “Monitor Out” setting is set to “Analog” and the “Resolution” setting is set to “Through”.

Specifications

Amplifier Section

THD (Total Harmonic Distortion)	0.05% (Power Rated)
Input Sensitivity and Impedance	200 mV/ 47 k Ω (LINE) 2.5 mV/47 k Ω (PHONO MM)
Output Level and Impedance	200 mV/ 470 Ω (REC OUT)
Phono Overload	70 mV (MM 1 kHz, 0.5%)
Frequency Response	5 Hz–100 kHz/ +1 dB–3 dB (Direct mode)
Tone Control	\pm 10 dB, 20 Hz (BASS) \pm 10 dB, 20 kHz (TREBLE)
Signal to Noise Ratio	110 dB (LINE, IHF-A) 80 dB (PHONO, IHF-A)

Video Section

Input Sensitivity/Output Level and Impedance	1 V _{p-p} /75 Ω (Component and S-Video Y) 0.7 V _{p-p} /75 Ω (Component Pb/Cb,Pr/Cr) 0.28 V _{p-p} /75 Ω (S-Video C) 1 V _{p-p} /75 Ω (Composite)
Component Video Frequency Response	5 Hz – 100 MHz, –3 dB

Tuner Section

FM

Tuning Frequency Range	
North American:	87.5 MHz– 107.9 MHz
Australian:	87.50 MHz– 108.00 MHz, RDS

AM

Tuning Frequency Range	
North American:	530 kHz–1710 kHz
Australian:	522 kHz–1611 kHz
Preset Channel	40

Digital Tuner

North American:	XM, SIRIUS, HD RADIO
-----------------	----------------------

General

Power Supply	
North American:	AC 120 V, 60 Hz
Australian:	AC 220-240 V, 50/60 Hz
Power Consumption	
North American:	1.1 A
Australian:	85 W
Dimensions (W × H × D)	435 × 194 × 444.5 mm 17-1/8" × 7-5/8" × 17-1/2"
Weight	13.3 kg 29.3 lbs.

Video Input

HDMI	IN 1, IN 2, IN 3, IN 4
Component	IN 1 (DVD), IN 2, IN 3
S-Video	DVD, VCR/DVR, CBL/SAT, GAME/TV, AUX 1, AUX 2
Composite	DVD, VCR/DVR, CBL/SAT, GAME/TV, AUX 1, AUX 2

Video Output

HDMI	OUT MAIN, OUT SUB
Component	MONITOR OUT 1, MONITOR OUT 2/ZONE 2 OUT
S-Video	VCR/DVR OUT, MONITOR OUT
Composite	VCR/DVR OUT, MONITOR OUT, ZONE 2 OUT

Audio Inputs

Digital Inputs	OPTICAL: 2 (Rear), 1 (Front) COAXIAL: 3 (Rear)
Analog Inputs	MULTI CH (FRONT, CENTER, SUBWOOFER, SURR, SURR BACK), DVD, VCR/DVR, CBL/SAT, GAME/TV, AUX 1, TAPE, CD, PHONO, AUX 2
Balance Inputs	BALANCE L, BALANCE R
Multichannel Inputs	7.1

Audio Outputs

Digital Output	OPTICAL: 1 (Rear)
Analog Outputs	VCR/DVR OUT, TAPE OUT, PRE OUT (FRONT, CENTER, SUBWOOFER, SURR, SURR BACK, ZONE 2, ZONE 3)
Balance Pre Outputs	FL, FR, C, SL, SR, SBL, SBR, SW
Multichannel Pre Outputs	7
Subwoofer Pre Outputs	1
Phones	1

Control Terminal

MIC	Yes
RS232	1
Ether	1 (e-control)
IR Input/Output	2/1
12 V Trigger Out	3

Specifications and features are subject to change without notice.

Integra Division of
ONKYO U.S.A. CORPORATION
18 park Way, Upper Saddle River, N.J. 07458, U.S.A.
Tel: 201-818-9200 Fax: 201-785-2650 <http://www.integrahometheater.com>

Integra Division of
ONKYO CORPORATION
Sales & Product Planning Div.: 2-1, Nisshin-cho, Neyagawa-shi, OSAKA 572-8540, JAPAN
Tel: 072-831-8023 Fax: 072-831-8163



Y0810-2

SN 29344765A
(C) Copyright 2008 ONKYO CORPORATION Japan. All rights reserved.



* 2 9 3 4 4 7 6 5 A *